



L78MR00 Series

5 to 12V 0.5A 5-Pin Voltage Regulators with Reset Function

Overview

The L78MR00 series, 500mA general-purpose voltage regulator ICs provide reset output signal for microcomputers.

Features

- Reset function (power supply voltage monitor : Generates a reset signal at a power-on and temporal power-down).
- Output voltage
 L78MR05 : 5V (Reset output On-chip pull-up resistor)
~~L78MR06 : 6V (Reset output Open collector)~~
~~L78MR08 : 8V (Reset output Open collector)~~
~~L78MR09 : 9V (Reset output Open collector)~~
~~L78MR12 : 12V (Reset output Open collector)~~
- Output current 500mA
- On-chip ASO protector.
- On-chip thermal protector.
- On-chip overcurrent limiter.
- The use of package TO220-5H facilitates easy mounting and thermal design.
- Delay time (t_d) may be set by an external capacitor.

Package Dimensions

unit:mm
3079

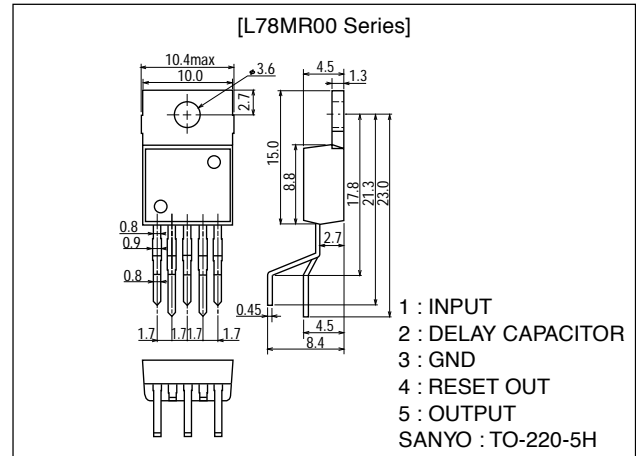

Equivalent Circuit

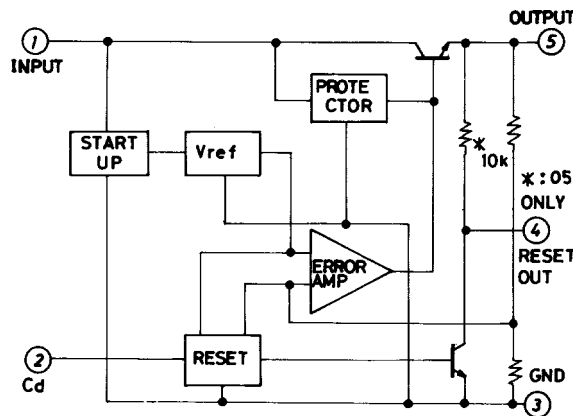

Unit (resistance: Ω)

■ Any and all SANYO products described or contained herein do not have specifications that can handle applications that require extremely high levels of reliability, such as life-support systems, aircraft's control systems, or other applications whose failure can be reasonably expected to result in serious physical and/or material damage. Consult with your SANYO representative nearest you before using any SANYO products described or contained herein in such applications.

■ SANYO assumes no responsibility for equipment failures that result from using products at values that exceed, even momentarily, rated values (such as maximum ratings, operating condition ranges, or other parameters) listed in products specifications of any and all SANYO products described or contained herein.

L78MR00 Series

Specifications

[Common to L78MR00 Series]

Maximum Ratings at $T_a = 25^\circ\text{C}$

Parameter	Symbol	Conditions	Ratings	Unit
Maximum Input Voltage	$V_{IN\ max}$		35	V
Reset Pin Supply Voltage	V_{reset}		35	V
Allowable Power Dissipation	$P_d\ max$	No fin	1.75	W
		$T_c=25^\circ\text{C}$	20	W
Operating Temperature	T_{opr}		-30 to +80	$^\circ\text{C}$
Storage Temperature	T_{stg}		-55 to +150	$^\circ\text{C}$

[L78MR05]

Recommended Operating Conditions at $T_a = 25^\circ\text{C}$

Parameter	Symbol	Conditions	Ratings	Unit
Input Voltage	V_{IN}		7.5 to 20	V
Output Current	I_{OUT}		5 to 500	mA

Operating Characteristics at $T_a = 25^\circ\text{C}$, $V_{IN}=10\text{V}$, $I_O=0.35\text{A}$, $C_O=10\mu\text{F}$

Parameter	Symbol	Conditions	Ratings			Unit
			min	typ	max	
Output Voltage	V_{O1}	$T_j=25^\circ\text{C}$	4.8	5.0	5.2	V
	V_{O2}	$7\text{V}\leq V_{IN}\leq 20\text{V}$, $5\text{mA}\leq I_O\leq 0.35\text{A}$	4.75		5.25	V
Line Regulation	ΔV_O	LN1 $T_j=25^\circ\text{C}$, $7\text{V}\leq V_{IN}\leq 25\text{V}$, $I_O=0.2\text{A}$		1.0	100	mV
		LN2 $T_j=25^\circ\text{C}$, $8\text{V}\leq V_{IN}\leq 25\text{V}$, $I_O=0.2\text{A}$		0.5	50	mV
Load Regulation	ΔV_O	LD1 $T_j=25^\circ\text{C}$, $5\text{mA}\leq I_O\leq 0.5\text{A}$		3.0	100	mV
		LD2 $T_j=25^\circ\text{C}$, $5\text{mA}\leq I_O\leq 0.2\text{A}$		1.5	50	mV
Current Dissipation	I_{CC}	$T_j=25^\circ\text{C}$		3.4	6.0	mA
Current Dissipation Variation (Line)	ΔI_{CC}	LN $8\text{V}\leq V_{IN}\leq 25\text{V}$, $I_O=0.2\text{A}$			0.8	mA
Current Dissipation Variation (Load)	ΔI_{CC}	LD $5\text{mA}\leq I_O\leq 0.35\text{A}$			0.5	mA
Output Noise Voltage	V_{NO}	$I_O=5\text{mA}$, $10\text{Hz}\leq f\leq 100\text{kHz}$		60		μV
Ripple Rejection	Rr1	$T_j=25^\circ\text{C}$, $f=120\text{Hz}$, $8\text{V}\leq V_{IN}\leq 18\text{V}$, $I_O=0.1\text{A}$	62	80		dB
	Rr2	$T_j=25^\circ\text{C}$, $f=120\text{Hz}$, $8\text{V}\leq V_{IN}\leq 18\text{V}$, $I_O=0.3\text{A}$	62	77		dB
Dropout Voltage	V_{drop}			2.0	2.5	V
Peak Output Current	I_{OP}	$T_j=25^\circ\text{C}$		1.1		A
Short Circuit Current	I_{OSC}	$T_j=25^\circ\text{C}$, $V_{IN}=35\text{V}$		0.02		A
Temperature Coefficient of Output Voltage	$\Delta V_O/\Delta T$	$I_O=5\text{mA}$, $T_j=25$ to 125°C		-0.3		$\text{mV}/^\circ\text{C}$
'L' Reset Output Voltage	V_{ORL}	$V_O\leq 4.5\text{V}$, $I_O=5\text{mA}$			0.2	V
Reset Threshold Voltage	V_{RT}	$I_O=5\text{mA}$	$V_O-0.3$	$V_O-0.2$		V
Reset Hysteresis Voltage	V_{RTH}	$I_O=5\text{mA}$		100		mV
Reset Output Delay Time	t_d	$C_d=0.1\mu\text{F}$, $I_O=5\text{mA}$		10		ms

[L78MR06]

Recommended Operating Conditions at $T_a = 25^\circ\text{C}$

Parameter	Symbol	Conditions	Ratings	Unit
Input Voltage	V_{IN}		8.5 to 21	V
Output Current	I_O		5 to 500	mA
Reset Output Current	I_{OR}	$V_O\leq 5.64\text{V}$	20 max	mA

Continued on next page.

L78MR00 Series

Continued from preceding page.

Operating Characteristics at $T_a = 25^\circ\text{C}$, $V_{IN} = 11\text{V}$, $I_O = 0.35\text{A}$, $C_O = 10\mu\text{F}$

Parameter	Symbol	Conditions	Ratings			Unit
			min	typ	max	
Output Voltage	V_{O1}	$T_J = 25^\circ\text{C}$	5.75	6.0	6.25	V
	V_{O2}	$8\text{V} \leq V_{IN} \leq 21\text{V}$, $5\text{mA} \leq I_O \leq 0.35\text{A}$	5.7		6.3	V
Line Regulation	ΔV_O	LN1 $T_J = 25^\circ\text{C}$, $8\text{V} \leq V_{IN} \leq 25\text{V}$, $I_O = 0.2\text{A}$		1.2	100	mV
		LN2 $T_J = 25^\circ\text{C}$, $9\text{V} \leq V_{IN} \leq 25\text{V}$, $I_O = 0.2\text{A}$		0.6	50	mV
Load Regulation	ΔV_O	LD1 $T_J = 25^\circ\text{C}$, $5\text{mA} \leq I_O \leq 0.5\text{A}$		4.0	120	mV
		LD2 $T_J = 25^\circ\text{C}$, $5\text{mA} \leq I_O \leq 0.2\text{A}$		2.0	60	mV
Current Dissipation	I_{CC}	$T_J = 25^\circ\text{C}$		3.4	6.0	mA
Current Dissipation Variation (Line)	ΔI_{CC}	LN $9\text{V} \leq V_{IN} \leq 25\text{V}$, $I_O = 0.2\text{A}$			0.8	mA
Current Dissipation Variation (Load)	ΔI_{CC}	LD $5\text{mA} \leq I_O \leq 0.35\text{A}$			0.5	mA
Output Noise Voltage	V_{NO}	$I_O = 5\text{mA}$, $10\text{Hz} \leq f \leq 100\text{kHz}$		70		μV
Ripple Rejection	Rr1	$T_J = 25^\circ\text{C}$, $f = 120\text{Hz}$, $9\text{V} \leq V_{IN} \leq 19\text{V}$, $I_O = 0.1\text{A}$	59	80		dB
	Rr2	$T_J = 25^\circ\text{C}$, $f = 120\text{Hz}$, $9\text{V} \leq V_{IN} \leq 19\text{V}$, $I_O = 0.3\text{A}$	59	75		dB
Dropout Voltage	V_{drop}			2.0	2.5	V
Peak Output Current	I_{OP}	$T_J = 25^\circ\text{C}$		1.1		A
Short Circuit Current	I_{OSC}	$T_J = 25^\circ\text{C}$, $V_{IN} = 35\text{V}$		0.02		A
Temperature Coefficient of Output Voltage	$\Delta V_O / \Delta T$	$I_O = 5\text{mA}$, $T_J = 25$ to 125°C		-0.4		$\text{mV}/^\circ\text{C}$
'L' Reset Output Voltage	V_{ORL}	$V_O \leq 5.64\text{V}$, $I_{OR} = 20\text{mA}$, $I_O = 5\text{mA}$			0.8	V
Reset Output Leakage Current	I_{RL}	$V_R = 35\text{V}$			50	μA
Reset Threshold Voltage	V_{RT}	$I_O = 5\text{mA}$	$V_O - 0.36$	$V_O - 0.24$		V
Reset Hysteresis Voltage	V_{RTH}	$I_O = 5\text{mA}$		120		mV
Reset Output Delay Time	t_d	$C_d = 0.1\mu\text{F}$, $I_O = 5\text{mA}$		10		ms

[L78MR08]

Recommended Operating Conditions at $T_a = 25^\circ\text{C}$

Parameter	Symbol	Conditions	Ratings	Unit
Input Voltage	V_{IN}		10.5 to 23	V
Output Current	I_O		5 to 500	mA
Reset Output Current	I_{OR}	$V_O \leq 7.2\text{V}$	20 max	mA

Operating Characteristics at $T_a = 25^\circ\text{C}$, $V_{IN} = 14\text{V}$, $I_O = 0.35\text{A}$, $C_O = 10\mu\text{F}$

Parameter	Symbol	Conditions	Ratings			Unit
			min	typ	max	
Output Voltage	V_{O1}	$T_J = 25^\circ\text{C}$	7.7	8.0	8.3	V
	V_{O2}	$10.5\text{V} \leq V_{IN} \leq 23\text{V}$, $5\text{mA} \leq I_O \leq 0.35\text{A}$	7.6		8.4	V
Line Regulation	ΔV_O	LN1 $T_J = 25^\circ\text{C}$, $10.5\text{V} \leq V_{IN} \leq 25\text{V}$, $I_O = 0.2\text{A}$		1.6	100	mV
		LN2 $T_J = 25^\circ\text{C}$, $11\text{V} \leq V_{IN} \leq 25\text{V}$, $I_O = 0.2\text{A}$		0.8	50	mV
Load Regulation	ΔV_O	LD1 $T_J = 25^\circ\text{C}$, $5\text{mA} \leq I_O \leq 0.5\text{A}$		5.0	160	mV
		LD2 $T_J = 25^\circ\text{C}$, $5\text{mA} \leq I_O \leq 0.2\text{A}$		2.0	80	mV
Current Dissipation	I_{CC}	$T_J = 25^\circ\text{C}$		3.5	6.0	mA
Current Dissipation Variation (Line)	ΔI_{CC}	LN $10.5\text{V} \leq V_{IN} \leq 25\text{V}$, $I_O = 0.2\text{A}$			0.8	mA
Current Dissipation Variation (Load)	ΔI_{CC}	LD $5\text{mA} \leq I_O \leq 0.35\text{A}$			0.5	mA
Output Noise Voltage	V_{NO}	$I_O = 5\text{mA}$, $10\text{Hz} \leq f \leq 100\text{kHz}$		100		μV
Ripple Rejection	Rr1	$T_J = 25^\circ\text{C}$, $f = 120\text{Hz}$, $11.5\text{V} \leq V_{IN} \leq 21.5\text{V}$, $I_O = 0.1\text{A}$	56	75		dB
	Rr2	$T_J = 25^\circ\text{C}$, $f = 120\text{Hz}$, $11.5\text{V} \leq V_{IN} \leq 21.5\text{V}$, $I_O = 0.3\text{A}$	56	71		dB
Dropout Voltage	V_{drop}			2.0	2.5	V
Peak Output Current	I_{OP}	$T_J = 25^\circ\text{C}$		1.1		A
Short Circuit Current	I_{OSC}	$T_J = 25^\circ\text{C}$, $V_{IN} = 35\text{V}$		0.02		A
Temperature Coefficient of Output Voltage	$\Delta V_O / \Delta T$	$I_O = 5\text{mA}$, $T_J = 25$ to 125°C		-0.7		$\text{mV}/^\circ\text{C}$
'L' Reset Output Voltage	V_{ORL}	$V_O \leq 7.2\text{V}$, $I_{OR} = 20\text{mA}$, $I_O = 5\text{mA}$			0.8	V
Reset Output Leakage Current	I_{RL}	$V_R = 35\text{V}$			50	μA
Reset Threshold Voltage	V_{RT}	$I_O = 5\text{mA}$	$V_O - 0.48$	$V_O - 0.32$		V
Reset Hysteresis Voltage	V_{RTH}	$I_O = 5\text{mA}$		160		mV
Reset Output Delay Time	t_d	$C_d = 0.1\mu\text{F}$, $I_O = 5\text{mA}$		10		ms

L78MR00 Series

[L78MR09]

Recommended Operating Conditions at $T_a = 25^\circ\text{C}$

Parameter	Symbol	Conditions	Ratings	Unit
Input Voltage	V_{IN}		12 to 24	V
Output Current	I_O		5 to 500	mA
Reset Output Current	I_{OR}	$V_O \leq 8.1\text{V}$	20 max	mA

Operating Characteristics at $T_a = 25^\circ\text{C}$, $V_{IN} = 15\text{V}$, $I_O = 0.35\text{A}$, $C_O = 10\mu\text{F}$

Parameter	Symbol	Conditions	Ratings			Unit
			min	typ	max	
Output Voltage	V_{O1}	$T_J = 25^\circ\text{C}$	8.6	9.0	9.4	V
	V_{O2}	$11.5\text{V} \leq V_{IN} \leq 24\text{V}$, $5\text{mA} \leq I_O \leq 0.35\text{A}$	8.5		9.5	V
Line Regulation	ΔV_O	LN1	$T_J = 25^\circ\text{C}$, $11.5\text{V} \leq V_{IN} \leq 25\text{V}$, $I_O = 0.2\text{A}$	1.6	100	mV
		LN2	$T_J = 25^\circ\text{C}$, $12\text{V} \leq V_{IN} \leq 25\text{V}$, $I_O = 0.2\text{A}$	0.8	50	mV
Load Regulation	ΔV_O	LD1	$T_J = 25^\circ\text{C}$, $5\text{mA} \leq I_O \leq 0.5\text{A}$	5.0	180	mV
		LD2	$T_J = 25^\circ\text{C}$, $5\text{mA} \leq I_O \leq 0.2\text{A}$	3.0	90	mV
Current Dissipation	I_{CC}	$T_J = 25^\circ\text{C}$	3.5	6.0	mA	
Current Dissipation Variation (Line)	ΔI_{CC}	LN	$11.5\text{V} \leq V_{IN} \leq 25\text{V}$, $I_O = 0.2\text{A}$		0.8	mA
Current Dissipation Variation (Load)	ΔI_{CC}	LD	$5\text{mA} \leq I_O \leq 0.35\text{A}$		0.5	mA
Output Noise Voltage	V_{NO}	$I_O = 5\text{mA}$, $10\text{Hz} \leq f \leq 100\text{kHz}$	110		μV	
Ripple Rejection	Rr1	$T_J = 25^\circ\text{C}$, $f = 120\text{Hz}$, $12\text{V} \leq V_{IN} \leq 22\text{V}$, $I_O = 0.1\text{A}$	56	73	dB	
	Rr2	$T_J = 25^\circ\text{C}$, $f = 120\text{Hz}$, $12\text{V} \leq V_{IN} \leq 22\text{V}$, $I_O = 0.3\text{A}$	56	70	dB	
Dropout Voltage	V_{drop}		2.0	2.5	V	
Peak Output Current	I_{OP}	$T_J = 25^\circ\text{C}$	1.1		A	
Short Circuit Current	I_{OSC}	$T_J = 25^\circ\text{C}$, $V_{IN} = 35\text{V}$	0.02		A	
Temperature Coefficient of Output Voltage	$\Delta V_O / \Delta T$	$I_O = 5\text{mA}$, $T_J = 25$ to 125°C	-0.9		$\text{mV}/^\circ\text{C}$	
'L' Reset Output Voltage	V_{ORL}	$V_O \leq 8.1\text{V}$, $I_{OR} = 20\text{mA}$, $I_O = 5\text{mA}$			0.8	V
Reset Output Leakage Current	I_{RL}	$V_R = 35\text{V}$			50	μA
Reset Threshold Voltage	V_{RT}	$I_O = 5\text{mA}$	$V_O - 0.54$	$V_O - 0.36$		V
Reset Hysteresis Voltage	V_{RTH}	$I_O = 5\text{mA}$		180		mV
Reset Output Delay Time	t_d	$C_d = 0.1\mu\text{F}$, $I_O = 5\text{mA}$		10		ms

[L78MR12]

Recommended Operating Conditions at $T_a = 25^\circ\text{C}$

Parameter	Symbol	Conditions	Ratings	Unit
Input Voltage	V_{IN}		15 to 27	V
Output Current	I_O		5 to 500	mA
Reset Output Current	I_{OR}	$V_O \leq 10.8\text{V}$	20 max	mA

Continued on next page.

L78MR00 Series

Continued from preceding page.

Operating Characteristics at $T_a = 25^\circ\text{C}$, $V_{IN} = 19\text{V}$, $I_O = 0.35\text{A}$, $C_O = 10\mu\text{F}$

Parameter	Symbol	Conditions	Ratings			Unit	
			min	typ	max		
Output Voltage	V_{O1}	$T_J = 25^\circ\text{C}$	11.5	12.0	12.5	V	
	V_{O2}	$14.5\text{V} \leq V_{IN} \leq 27\text{V}$, $5\text{mA} \leq I_O \leq 0.35\text{A}$	11.4		12.6	V	
Line Regulation	ΔV_O	LN1	$T_J = 25^\circ\text{C}$, $14.5\text{V} \leq V_{IN} \leq 30\text{V}$, $I_O = 0.2\text{A}$		2.4	100	mV
		LN2	$T_J = 25^\circ\text{C}$, $16\text{V} \leq V_{IN} \leq 30\text{V}$, $I_O = 0.2\text{A}$		1.2	50	mV
Load Regulation	ΔV_O	LD1	$T_J = 25^\circ\text{C}$, $5\text{mA} \leq I_O \leq 0.5\text{A}$		7.0	240	mV
		LD2	$T_J = 25^\circ\text{C}$, $5\text{mA} \leq I_O \leq 0.2\text{A}$		4.0	120	mV
Current Dissipation	I_{CC}	$T_J = 25^\circ\text{C}$		3.7	6.0	mA	
Current Dissipation Variation (Line)	ΔI_{CC}	LN	$14.5\text{V} \leq V_{IN} \leq 30\text{V}$, $I_O = 0.2\text{A}$			0.8	mA
Current Dissipation Variation (Load)	ΔI_{CC}	LD	$5\text{mA} \leq I_O \leq 0.35\text{A}$			0.5	mA
Output Noise Voltage	V_{NO}	$I_O = 5\text{mA}$, $10\text{Hz} \leq f \leq 100\text{kHz}$		140		μV	
Ripple Rejection	Rr1	$T_J = 25^\circ\text{C}$, $f = 120\text{Hz}$, $15\text{V} \leq V_{IN} \leq 25\text{V}$, $I_O = 0.1\text{A}$	55	68		dB	
	Rr2	$T_J = 25^\circ\text{C}$, $f = 120\text{Hz}$, $15\text{V} \leq V_{IN} \leq 25\text{V}$, $I_O = 0.3\text{A}$	55	66		dB	
Dropout Voltage	V_{drop}			2.0	2.5	V	
Peak Output Current	I_{OP}	$T_J = 25^\circ\text{C}$		1.1		A	
Short Circuit Current	I_{OSC}	$T_J = 25^\circ\text{C}$, $V_{IN} = 35\text{V}$		0.02		A	
Temperature Coefficient of Output Voltage	$\Delta V_O / \Delta T$	$I_O = 5\text{mA}$, $T_J = 25$ to 125°C		-1.6		$\text{mV}/^\circ\text{C}$	
'L' Reset Output Voltage	V_{ORL}	$V_O \leq 10.8\text{V}$, $I_{OR} = 20\text{mA}$, $I_O = 5\text{mA}$			0.8	V	
Reset Output Leakage Current	I_{RL}	$V_R = 35\text{V}$			50	μA	
Reset Threshold Voltage	V_{RT}	$I_O = 5\text{mA}$	$V_O - 0.72$	$V_O - 0.48$		V	
Reset Hysteresis Voltage	V_{RTH}	$I_O = 5\text{mA}$		240		mV	
Reset Output Delay Time	t_d	$C_d = 0.1\mu\text{F}$, $I_O = 5\text{mA}$		10		ms	

Specified Application Circuit

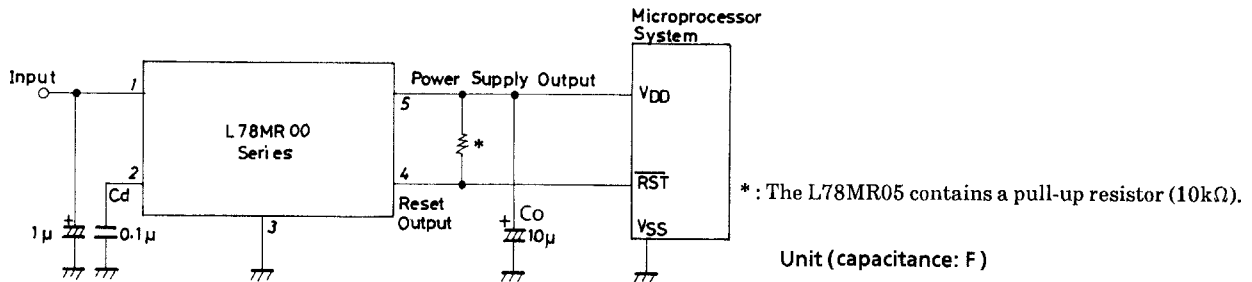

Note on use) If a load current (in particular, pulse-like load current) that is greater than a rated value is used, a reset signal may be generated due to the overload. Please keep it in mind.

L78MR05 Reset Operation

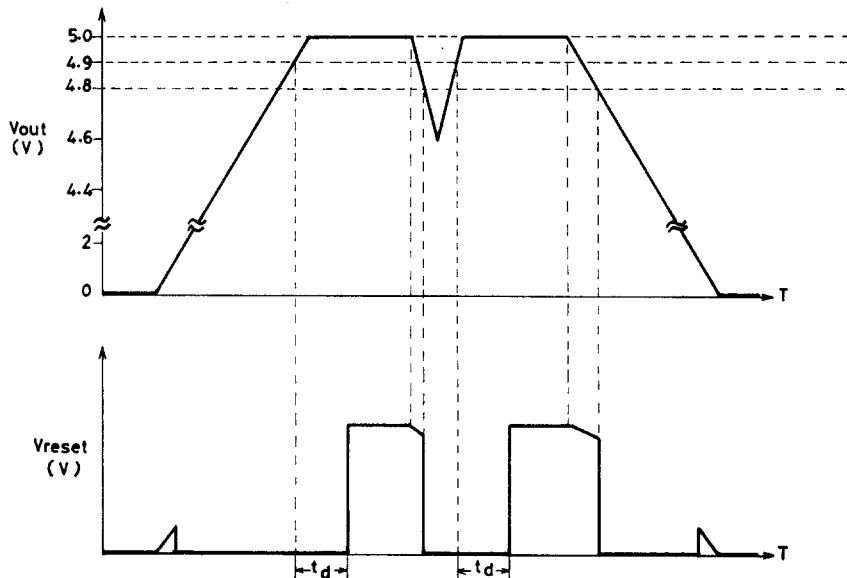

L78MR00 Series

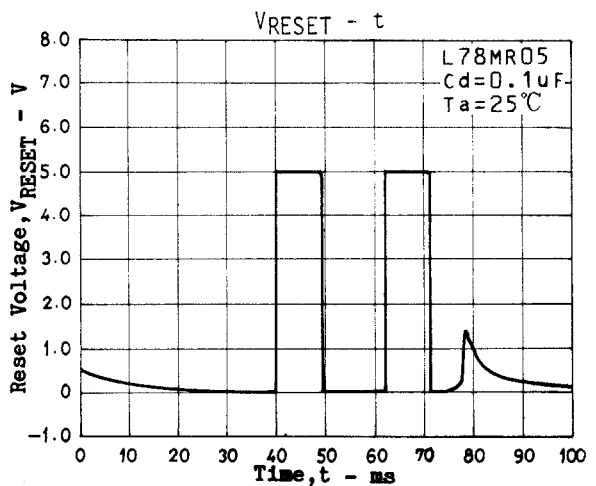
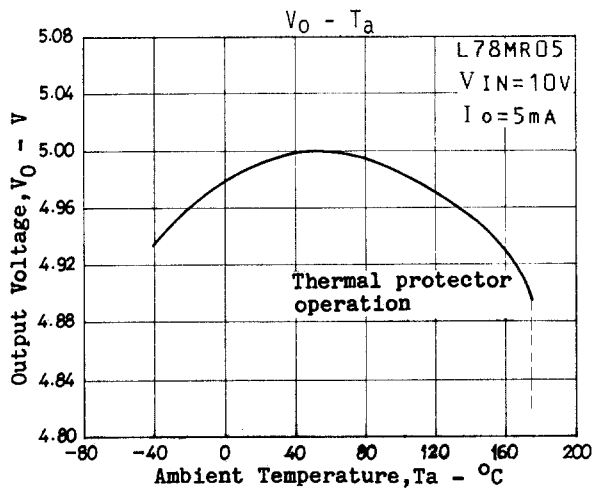
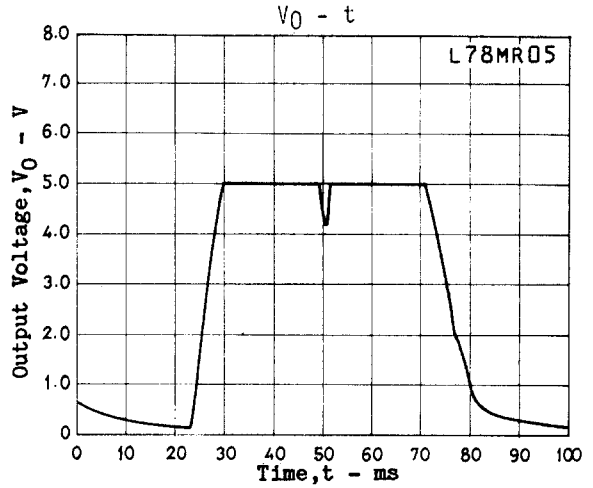
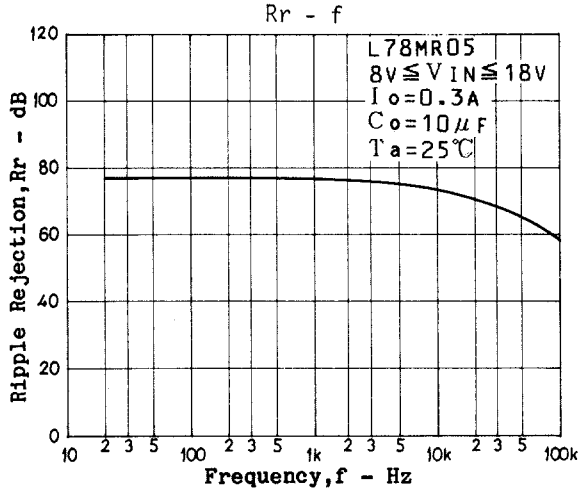
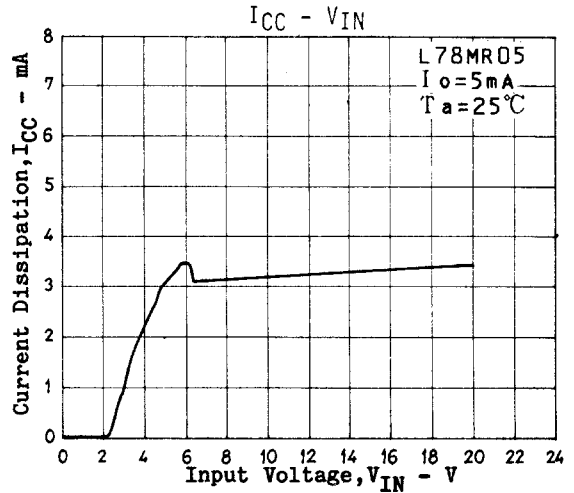
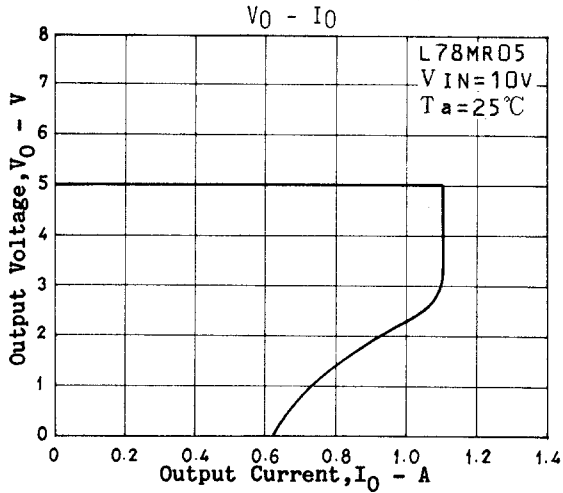
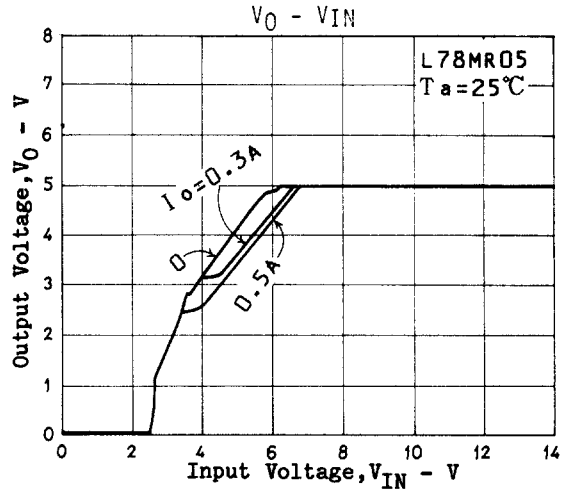
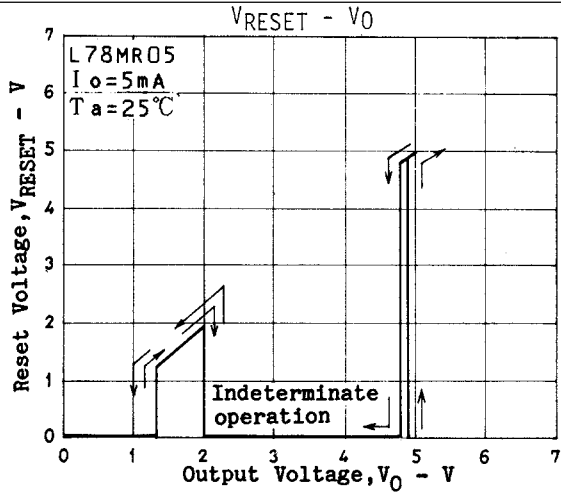

L78MR00 Series

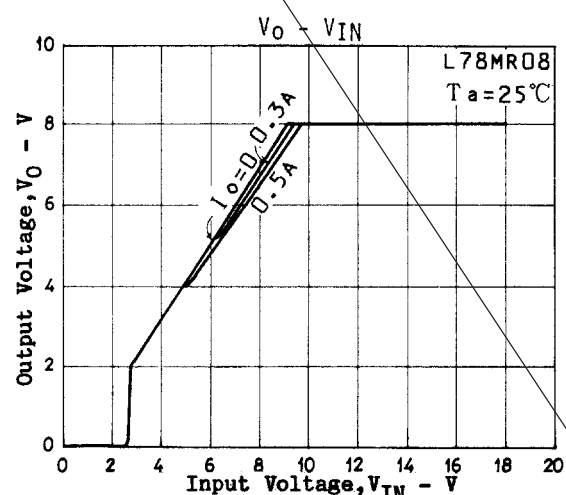
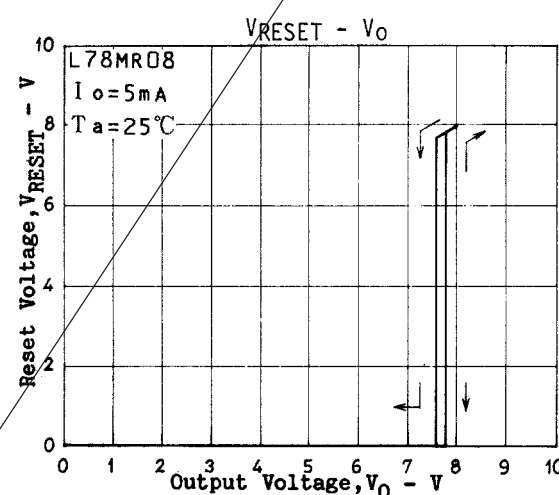
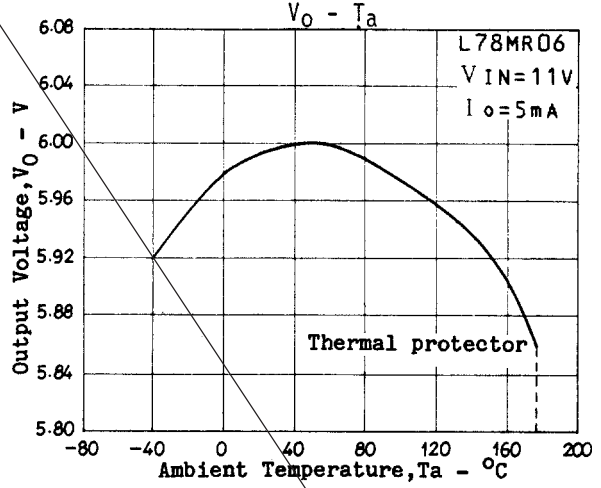
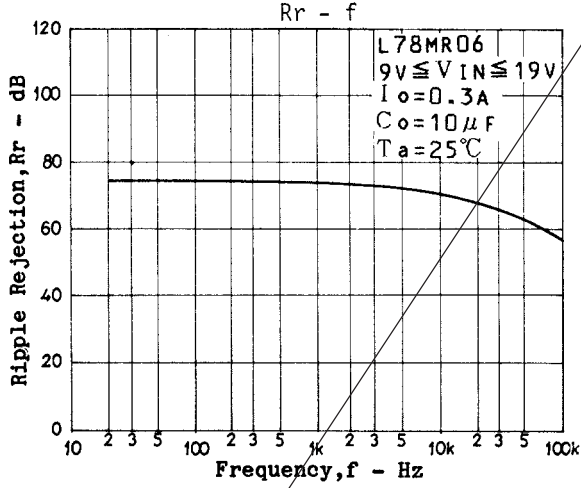
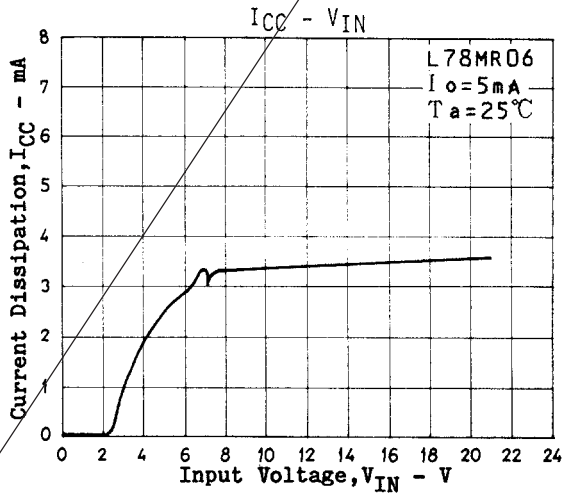
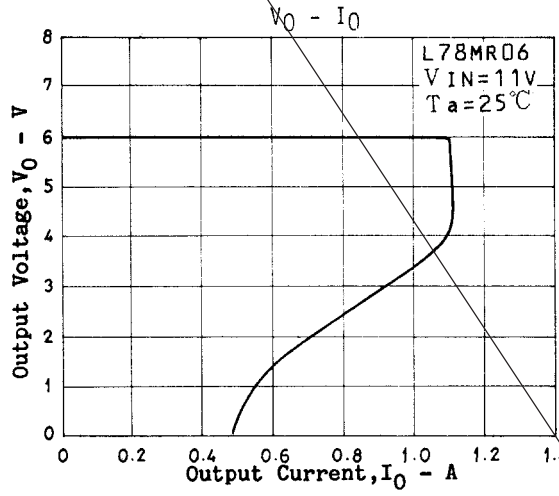
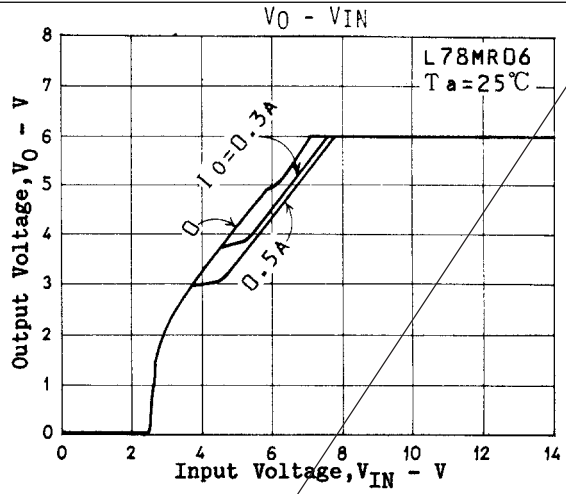
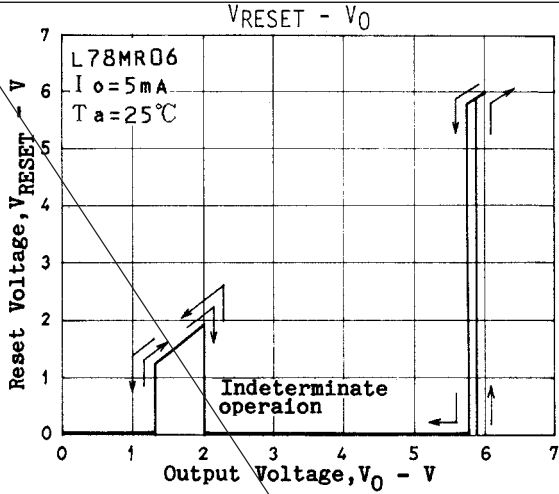

L78MR00 Series

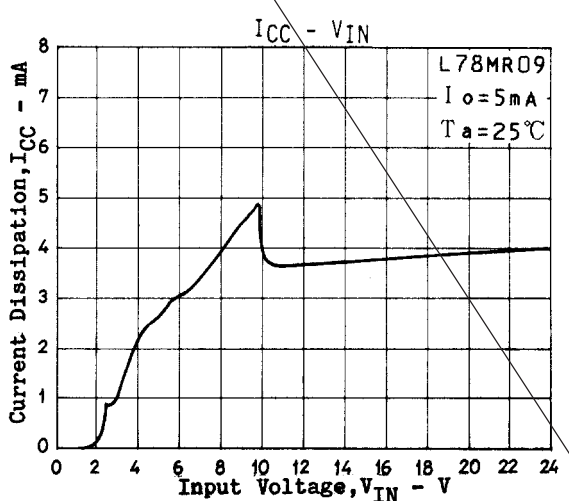
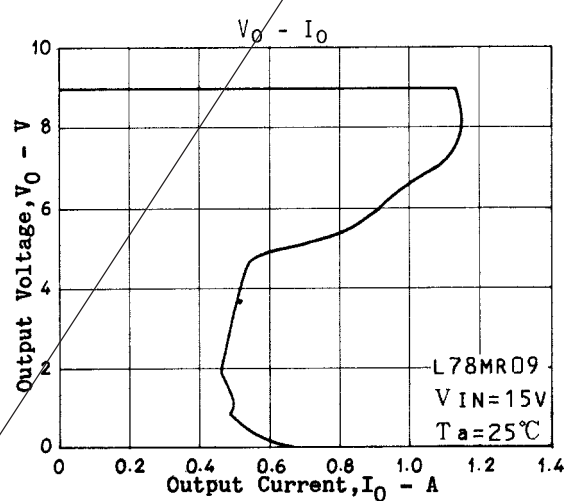
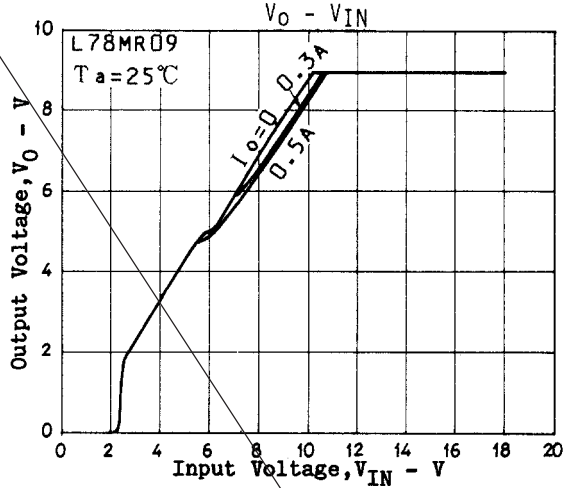
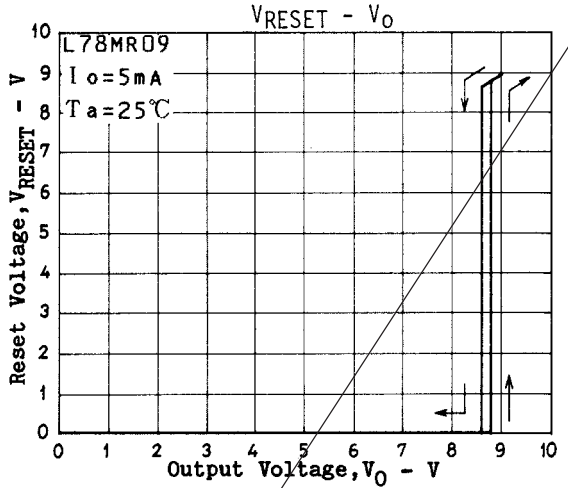
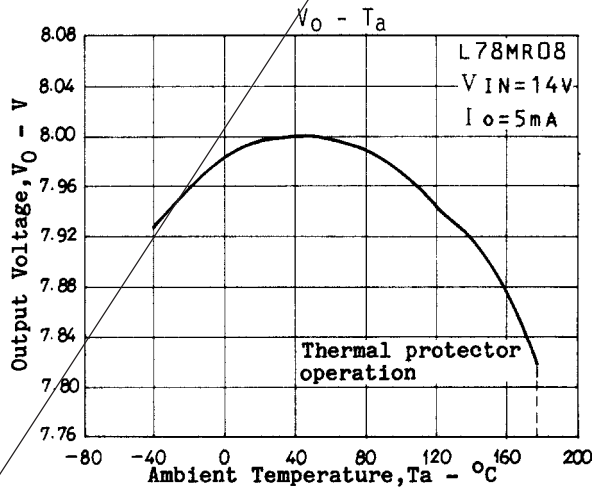
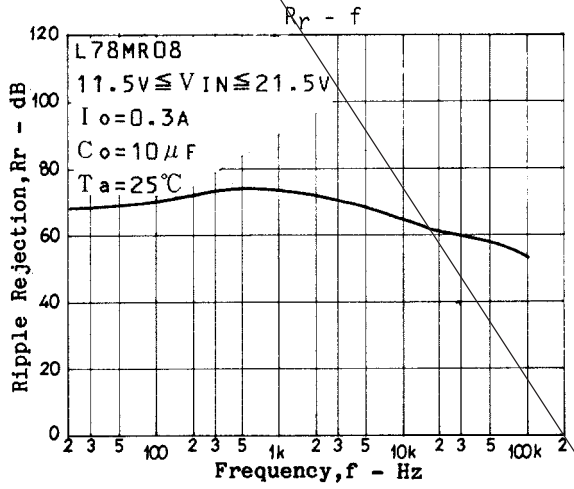
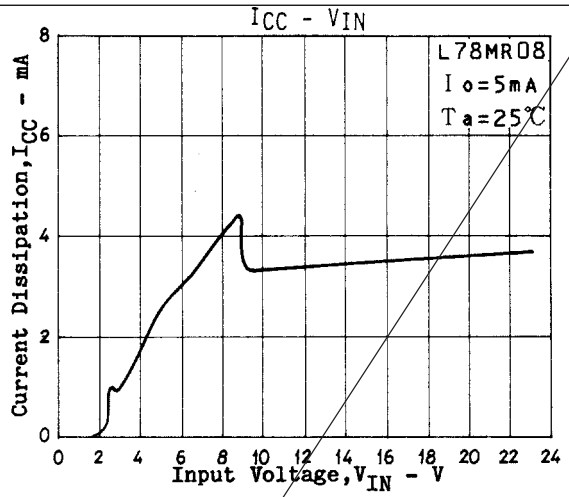
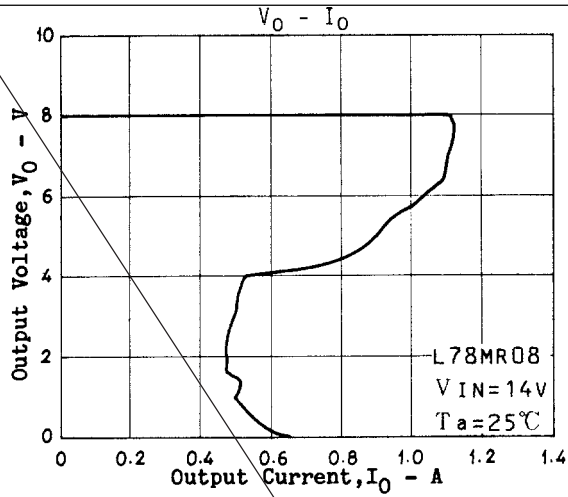

L78MR00 Series

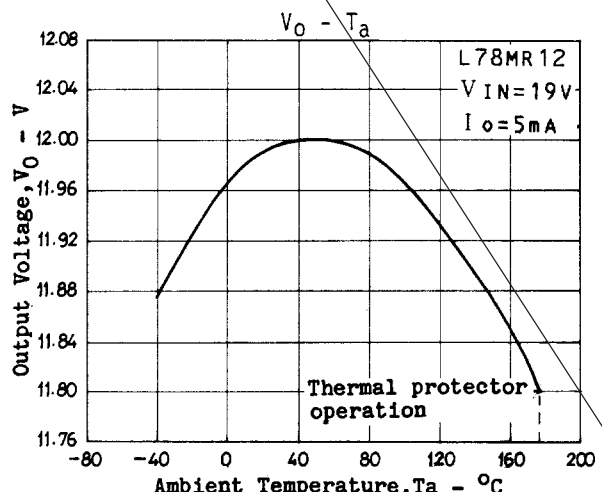
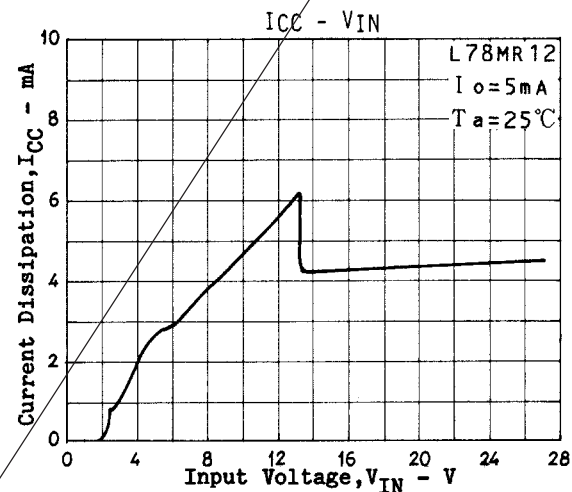
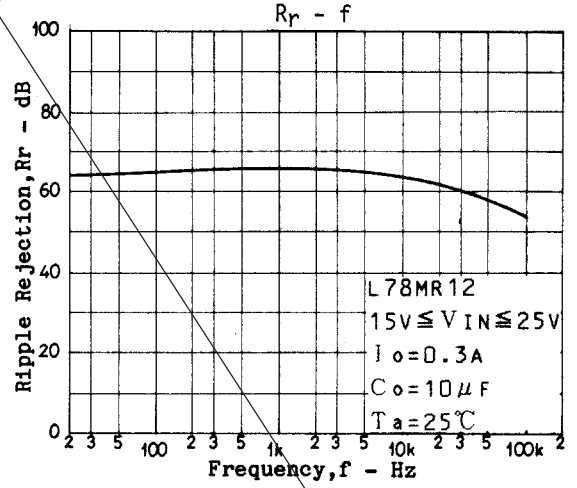
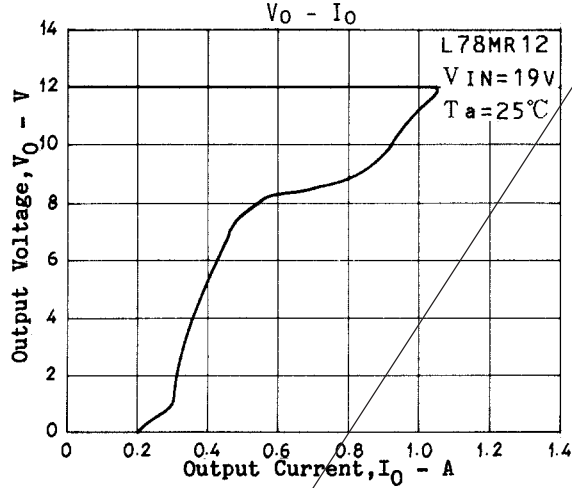
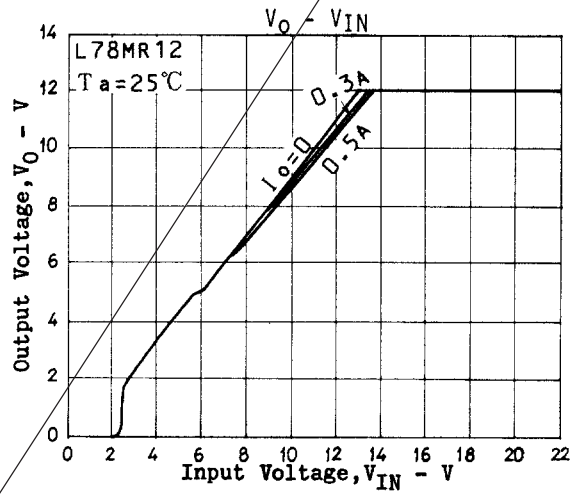
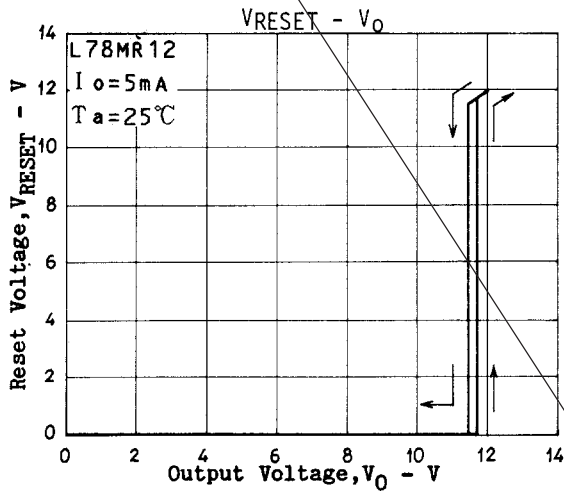
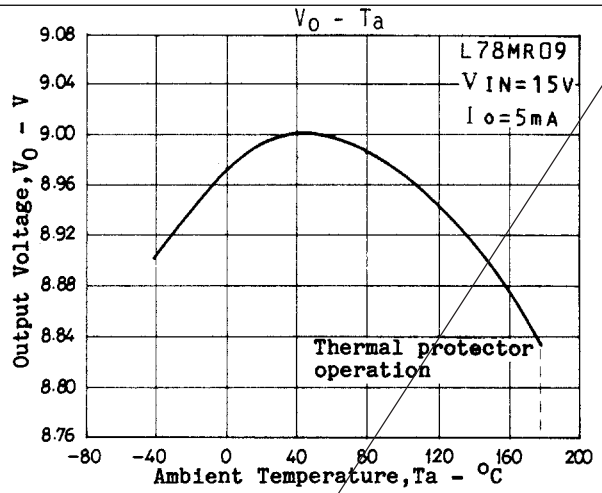
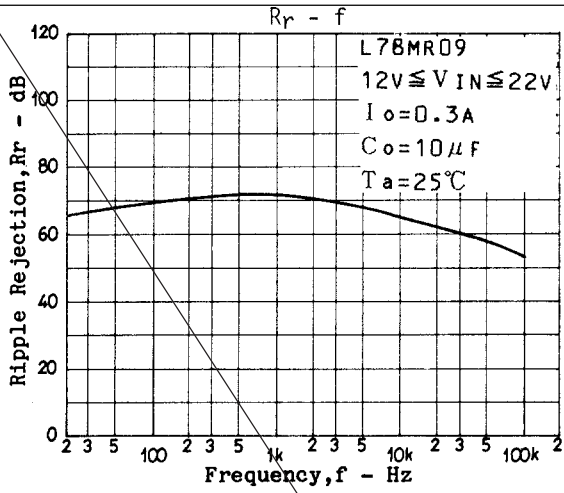

L78MR00 Series

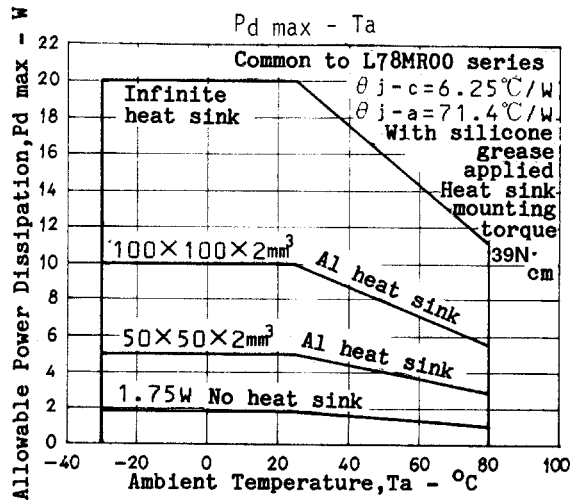
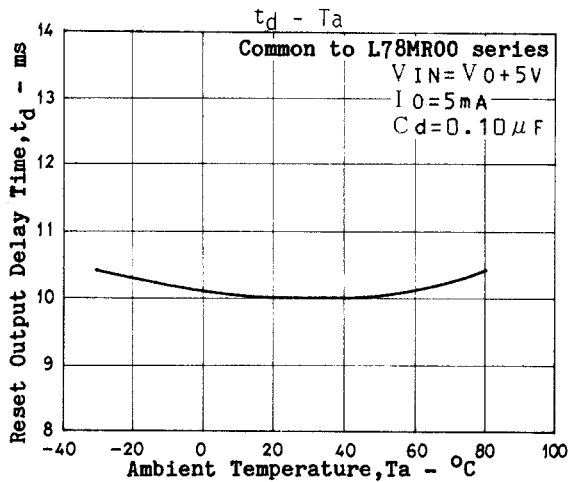
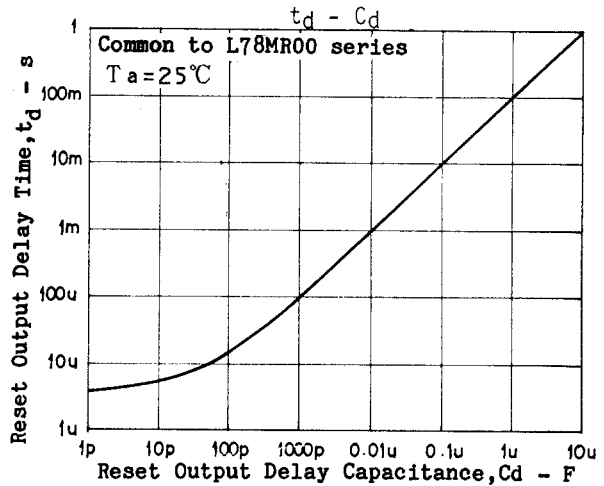
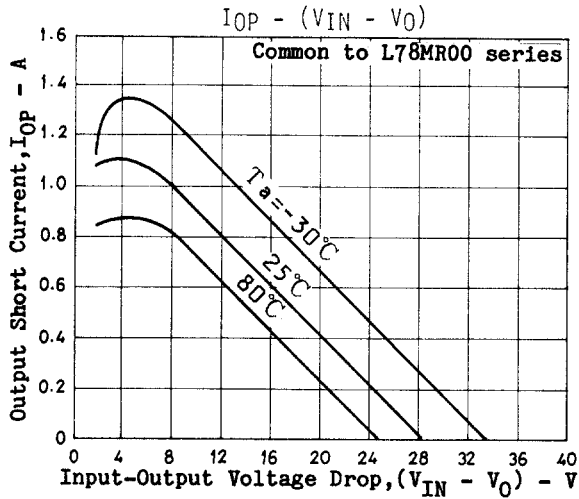

- Specifications of any and all SANYO products described or contained herein stipulate the performance, characteristics, and functions of the described products in the independent state, and are not guarantees of the performance, characteristics, and functions of the described products as mounted in the customer's products or equipment. To verify symptoms and states that cannot be evaluated in an independent device, the customer should always evaluate and test devices mounted in the customer's products or equipment.
- SANYO Electric Co., Ltd. strives to supply high-quality high-reliability products. However, any and all semiconductor products fail with some probability. It is possible that these probabilistic failures could give rise to accidents or events that could endanger human lives, that could give rise to smoke or fire, or that could cause damage to other property. When designing equipment, adopt safety measures so that these kinds of accidents or events cannot occur. Such measures include but are not limited to protective circuits and error prevention circuits for safe design, redundant design, and structural design.
- In the event that any or all SANYO products (including technical data, services) described or contained herein are controlled under any of applicable local export control laws and regulations, such products must not be exported without obtaining the export license from the authorities concerned in accordance with the above law.
- No part of this publication may be reproduced or transmitted in any form or by any means, electronic or mechanical, including photocopying and recording, or any information storage or retrieval system, or otherwise, without the prior written permission of SANYO Electric Co., Ltd.
- Any and all information described or contained herein are subject to change without notice due to product/technology improvement, etc. When designing equipment, refer to the "Delivery Specification" for the SANYO product that you intend to use.
- Information (including circuit diagrams and circuit parameters) herein is for example only; it is not guaranteed for volume production. SANYO believes information herein is accurate and reliable, but no guarantees are made or implied regarding its use or any infringements of intellectual property rights or other rights of third parties.

This catalog provides information as of January, 2000. Specifications and information herein are subject to change without notice.