

SPECIFICATION

DEVICE NAME : Power MOSFET

TYPE NAME : 2SK2561-01R

SPEC. No. :

Fuji Electric Co.,Ltd.

This Specification is subject to change without notice.

	DATE	NAME	APPROVED	Fuji Electric Co.,Ltd.		
DRAWN				DWG.NO.	1/11	
CHECKED						

1. Scope
This specifies Fuji power MOSFET 2SK2561-01R
2. Construction N-channel enhancement mode power MOSFET
3. Application for switching
4. Outview T0-3PF Outview See to 5/11 page
5. Absolute maximum ratings at $T_c=25^\circ\text{C}$ (unless otherwise specified)

Description	Symbol	Characteristics	Unit	Remarks
Drain-source voltage	V_{DS}	600	V	
Drain-gate voltage	V_{DGR}	600	V	$R_{GS}=20\text{K}\Omega$
Continuous Drain current	I_D	± 9	A	
Pulsed drain current	$I_{Dpulsec}$	± 27	A	
Gate-source voltage	V_{GS}	± 30	V	
Maximum power dissipation	P_D	80	W	
Operating and storage temperature range	T_{ch}	150	$^\circ\text{C}$	
	T_{stg}	-55 ~ +150	$^\circ\text{C}$	

6. Electrical characteristics at $T_c=25^\circ\text{C}$ (unless otherwise specified)
Static ratings

Description	Symbol	Conditions	Characteristics			Unit
			Min.	Typ.	Max.	
Drain-source breakdown voltage	BV_{DSS}	$I_D=1\text{mA}$ $V_{GS}=0\text{V}$	600			V
Gate threshold voltage	$V_{GS(th)}$	$I_D=1\text{mA}$ $V_{DS}=V_{GS}$	2.5	3.5	5.0	V
Zero gate voltage drain current	I_{DSS}	$V_{DS}=600\text{V}$ $V_{GS}=0\text{V}$	$T_{ch}=25^\circ\text{C}$	10	500	μA
	I_{DSS}		$T_{ch}=125^\circ\text{C}$	0.2	1.0	mA
Gate-source leakage current	I_{GSS}	$V_{GS}=\pm 30\text{V}$ $V_{DS}=0\text{V}$		10	100	nA
Drain-source on- state resistance	$R_{DS(on)}$	$I_D=5\text{A}$ $V_{GS}=10\text{V}$		0.85	1.2	Ω

Fuji Electric Co.,Ltd.

DWG.NO.

2/11

Dynamic ratings

Description	Symbol	Conditions	Characteristics			Unit
			Min.	Typ.	Max.	
Forward transconductance	g_{fs}	$I_D = 5\text{ A}$ $V_{DS} = 25\text{ V}$	4.0	6.0		S
Input capacitance	C_{iss}	$V_{DS} = 25\text{ V}$ $V_{GS} = 0\text{ V}$ $f = 1\text{ MHz}$		1200	1800	pF
Output capacitance	C_{oss}			150	230	pF
Reverse transfer capacitance	C_{rss}			60	90	pF
Turn-on time	$t_{d(on)}$	$V_{CC} = 300\text{ V}$ $V_{GS} = 10\text{ V}$ $I_D = 9\text{ A}$ $R_{GS} = 25\ \Omega$		30	45	ns
	t_r			80	120	ns
Turn-off time	$t_{d(off)}$			160	240	ns
	t_f			80	120	ns

Reverse diode

Description	Symbol	Conditions	Characteristics			Unit
			Min.	Typ.	Max.	
Avalanche capability	I_{AV}	$L = 100\ \mu\text{H}$, $T_{ch} = 25^\circ\text{C}$ * see Fig1 and 2	9			A
Diode forward on-voltage	V_{SD}	$I_F = 2 \times I_{DR}$ $V_{GS} = 0\text{ V}$, $T_{ch} = 25^\circ\text{C}$		1.1	1.5	V
Reverse recovery time	t_{rr}	$I_F = I_{DR}$ $V_{GS} = 0\text{ V}$ $-di_F/dt = 100\text{ A}/\mu\text{s}$ $T_{ch} = 25^\circ\text{C}$		500		ns
Reverse recovery charge	Q_{rr}				3.5	

7. Thermal resistance

Description	Symbol	Conditions	Characteristics			Unit
			Min.	Typ.	Max.	
Thermal resistance	$R_{th_{ch-c}}$				1.56	$^\circ\text{C}/\text{W}$
	$R_{th_{ch-a}}$				30.0	$^\circ\text{C}/\text{W}$

Fuji Electric Co.,Ltd.

DWG.NO.

3/11

Fig.1 Test circuit

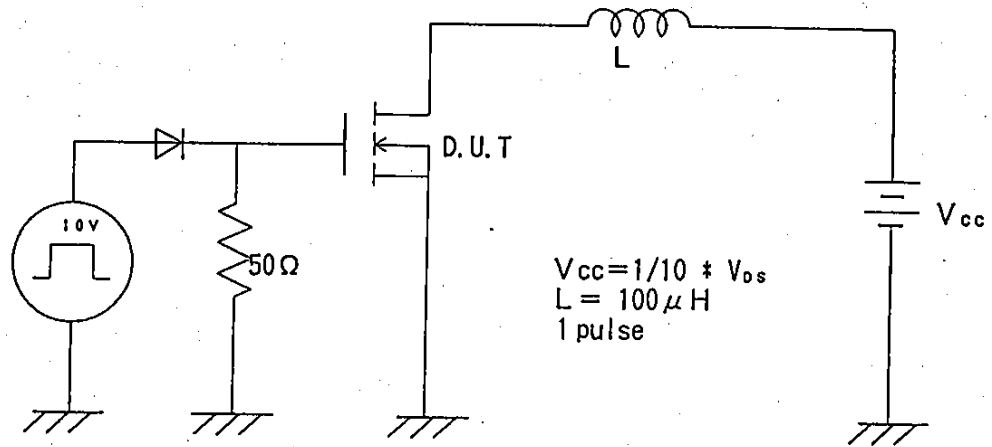
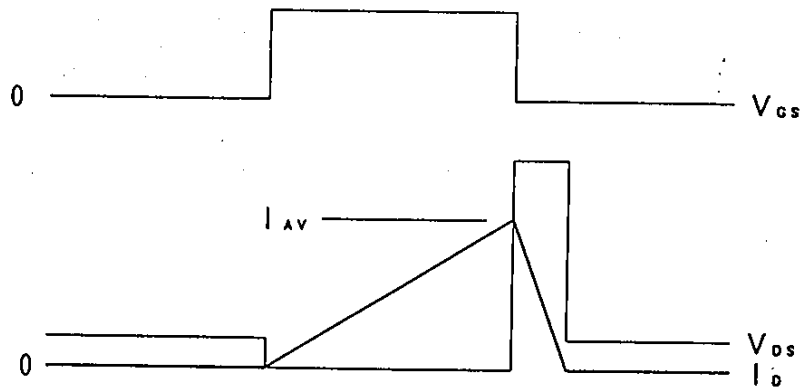
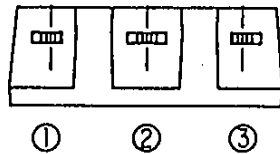
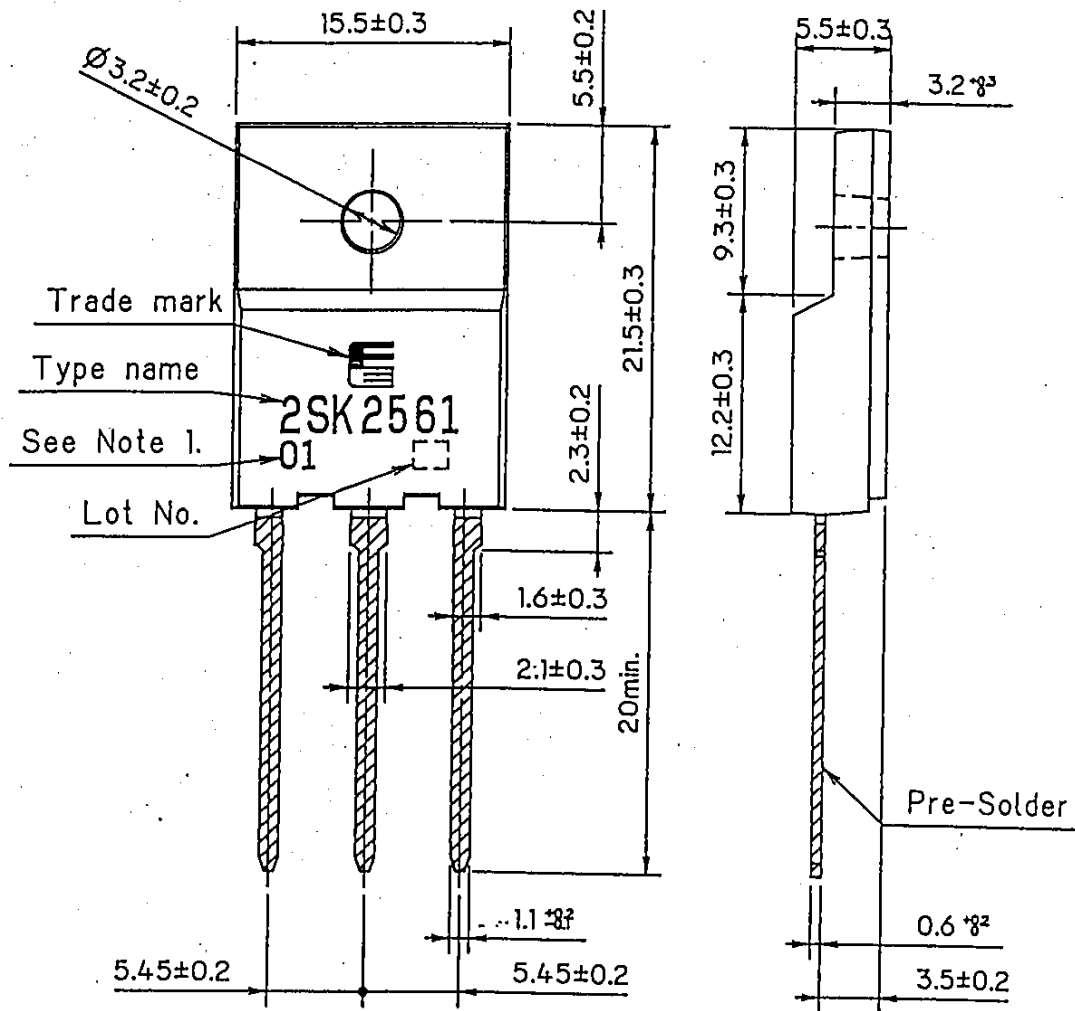

Fig.2 Operating waveforms



FUJI POWER MOSFET

TYPE : 2SK2561-01R



CONNECTION

- ① GATE
- ② DRAIN
- ③ SOURCE

Note 1. Guaranteed mark of avalanche ruggedness.

DIMENSIONS ARE IN MILLIMETERS.

Fuji Electric Co., Ltd.

DWG. NO.

5/11

Y 0257-R-003a

Power Dissipation

$PD=f(T_c)$

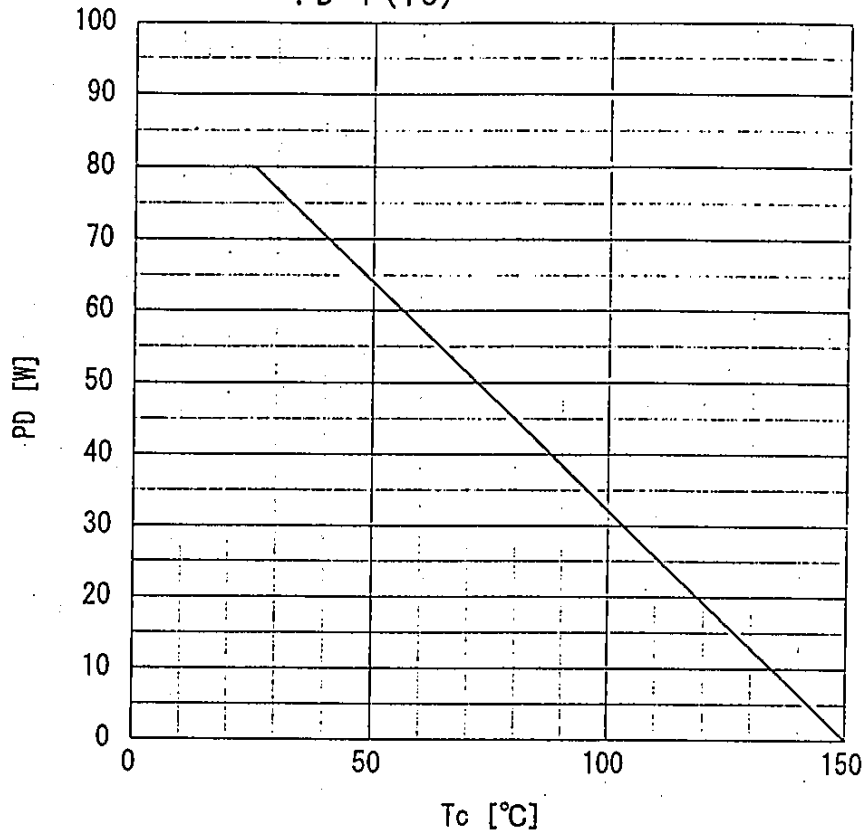

Safe operating area

$ID=f(V_{DS}) : D=0.01, T_c=25^\circ\text{C}$

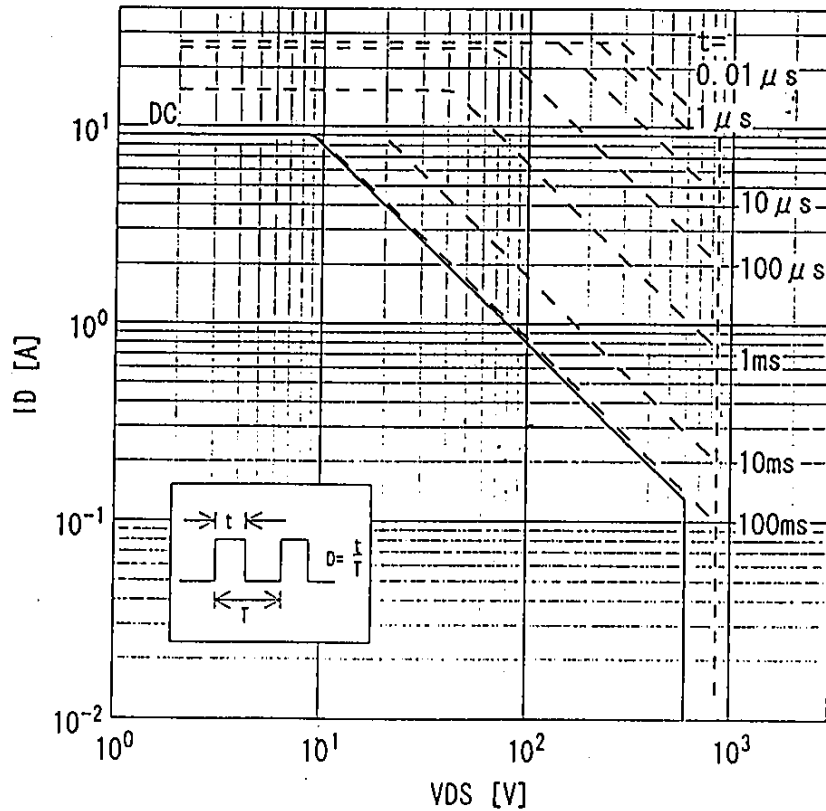

Typical output characteristics
 $I_D = f(V_{DS}) : 80 \mu s$ pulse test, $T_c = 25^\circ C$

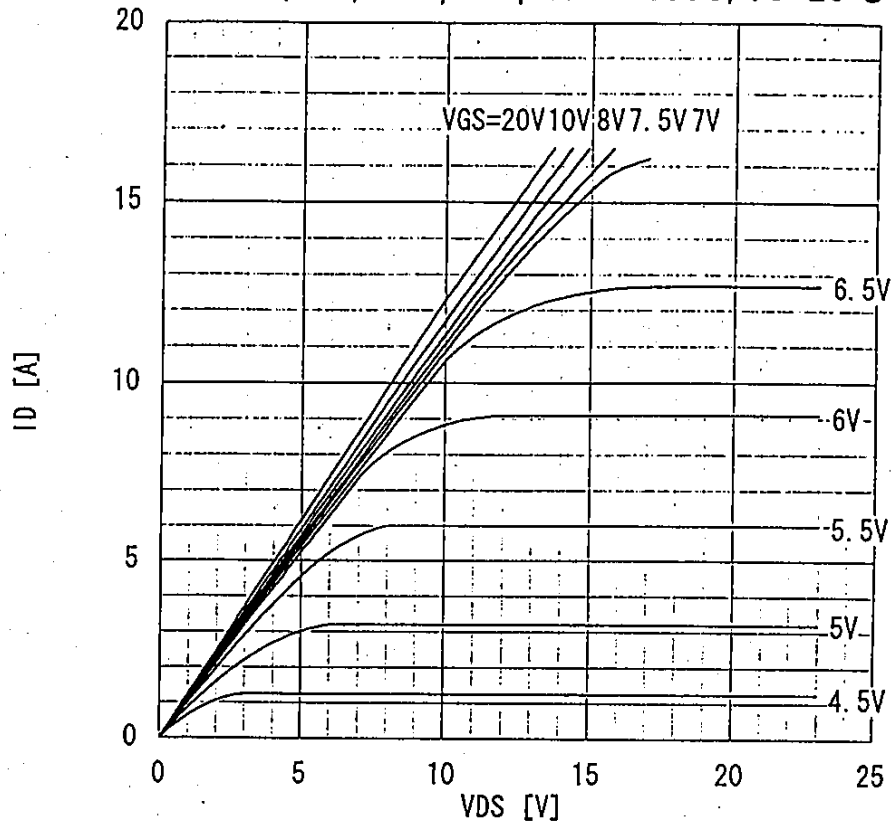

Typical transfer characteristic
 $I_D = f(V_{GS}) : 80 \mu s$ pulse test, $V_{DS} = 25V$, $T_{ch} = 25^\circ C$

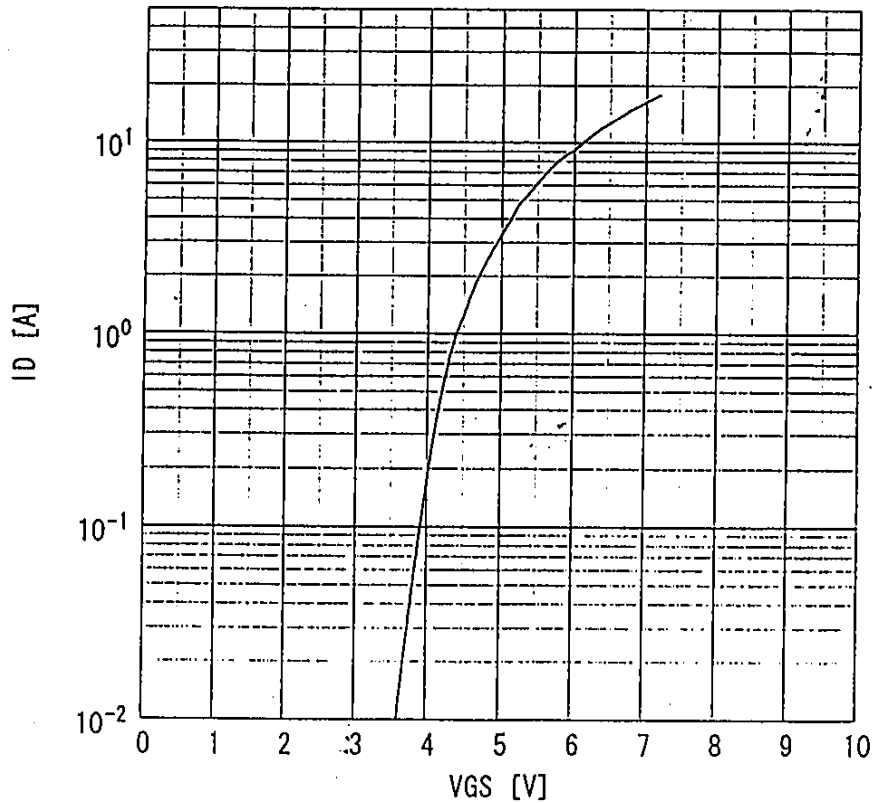

Typical forward transconductance
 $g_{fs} = f(I_D)$: 80 μ s pulse test, $V_{DS} = 25V$, $T_{ch} = 25^\circ C$

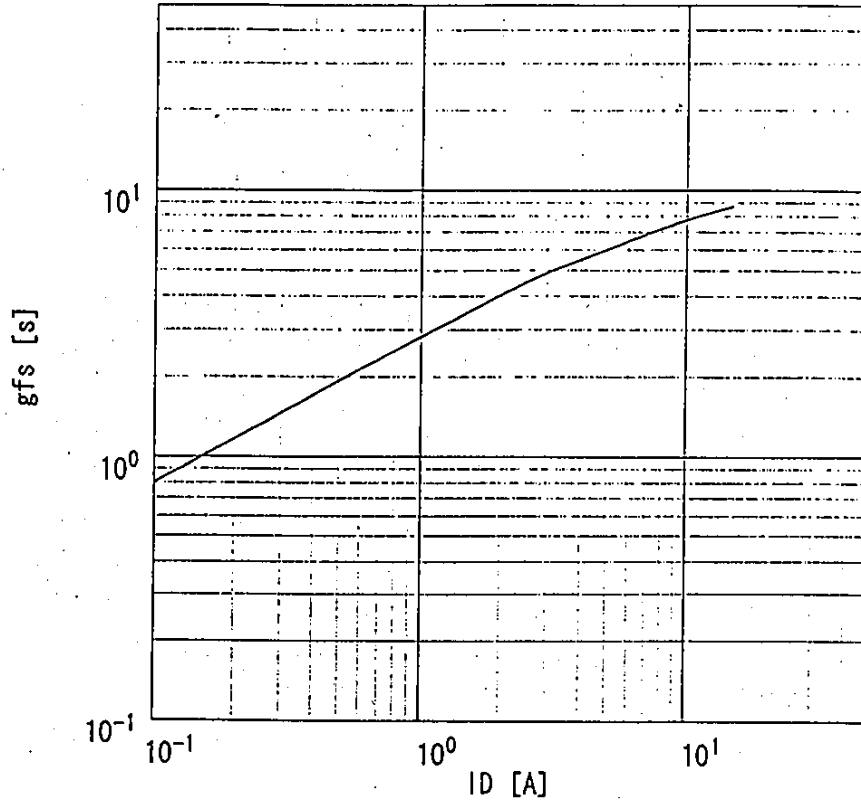

Typical drain-source on-state resistance
 $R_{DS(on)} = f(I_D)$: 80 μ s pulse test, $T_c = 25^\circ C$

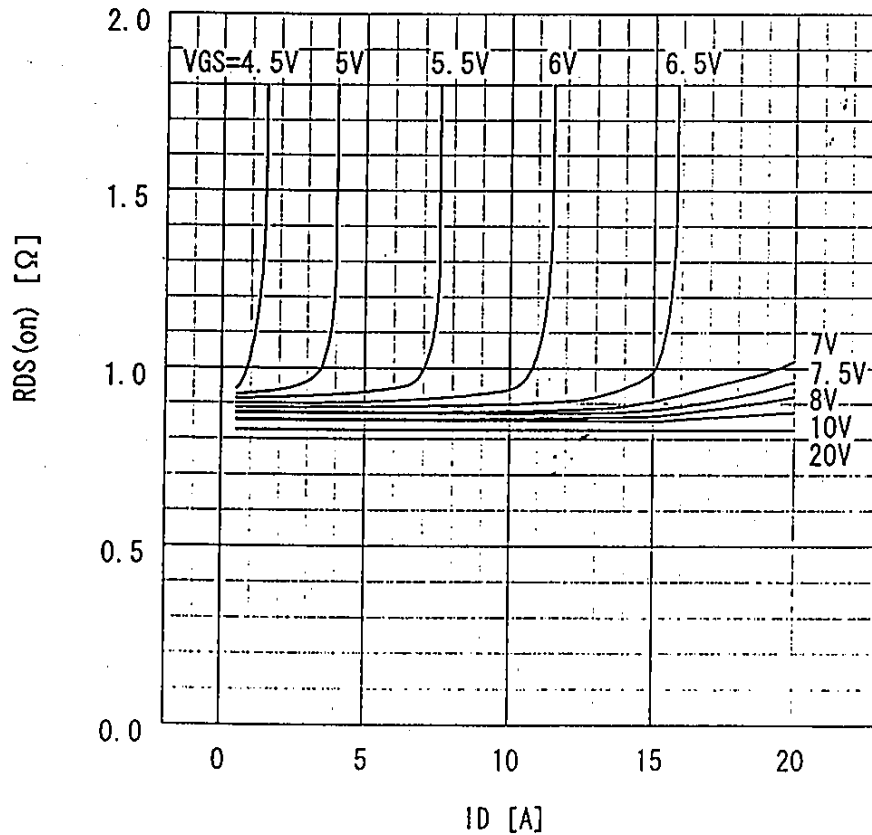

Drain-source on-state resistance
 $R_{DS(on)} = f(T_{ch}) : I_D = 5A, V_{GS} = 10V$

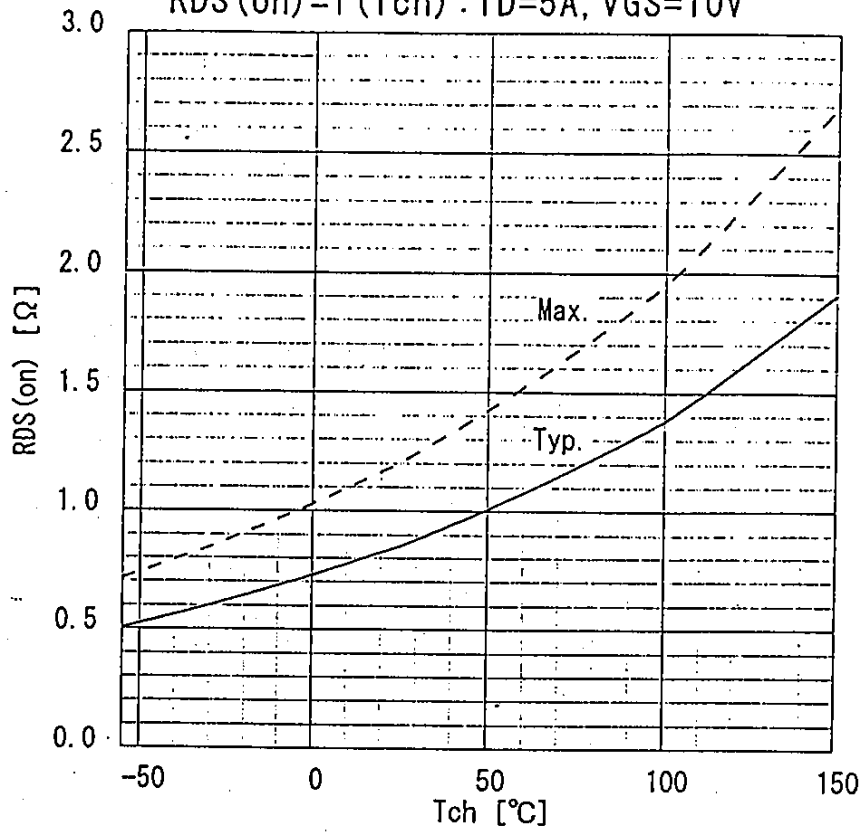

Gate threshold voltage
 $V_{GS(th)} = f(T_{ch}) : I_D = 1mA, V_{DS} = V_{GS}$

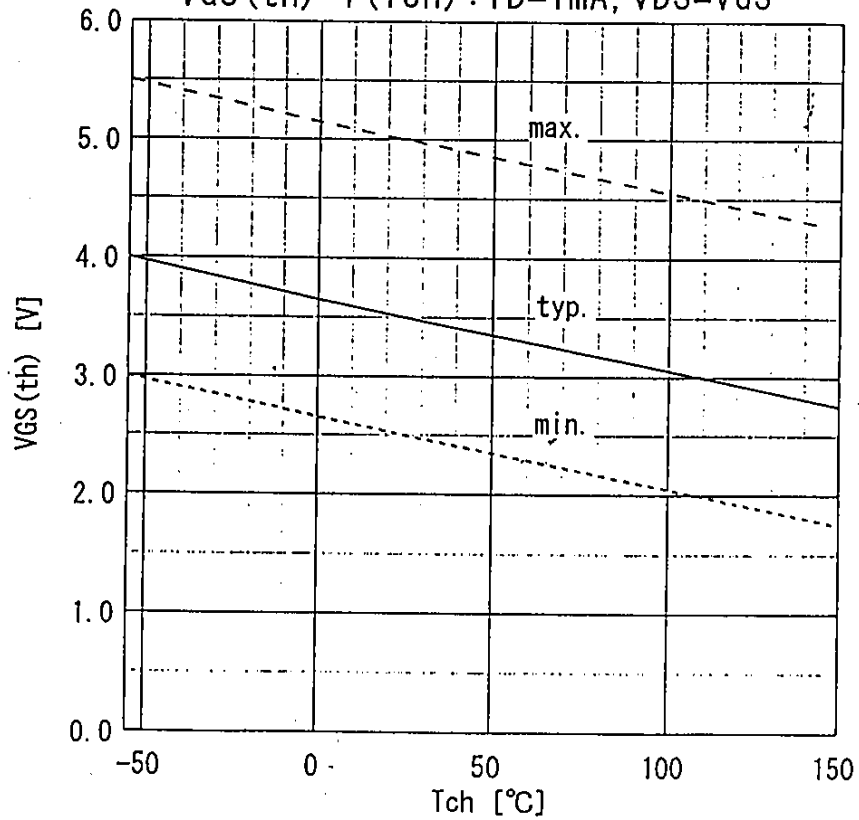

Typical gate charge characteristic
 $V_{GS} = f(Q_g) : I_D = 7A, T_c = 25^\circ C$

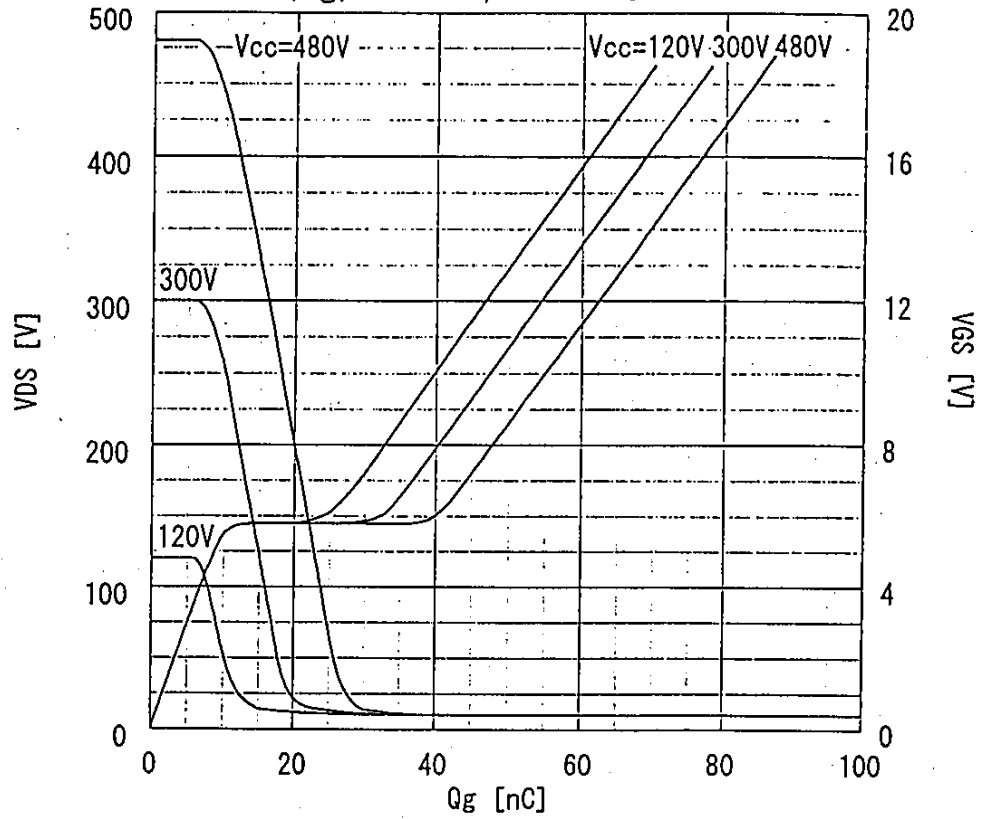

Typical capacitances
 $C = f(V_{DS}) : V_{GS} = 0V, f = 1MHz$

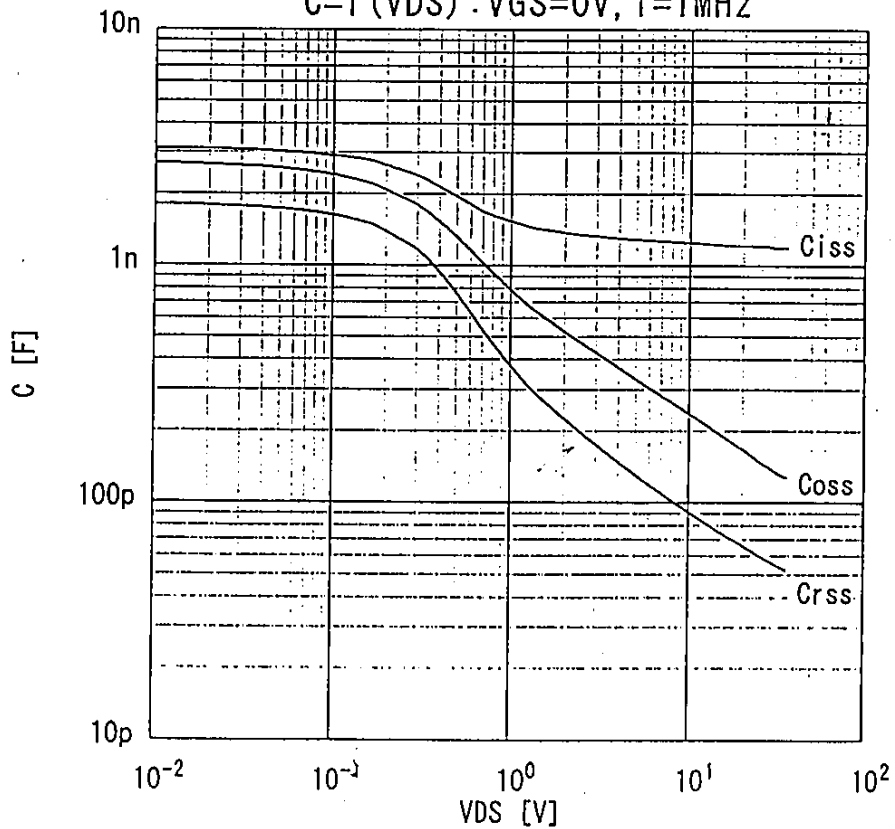

Forward characteristic of reverse of diode
 $I_F = f(V_{SD}) : 80 \mu s$ pulses test, $V_{GS} = 0V$

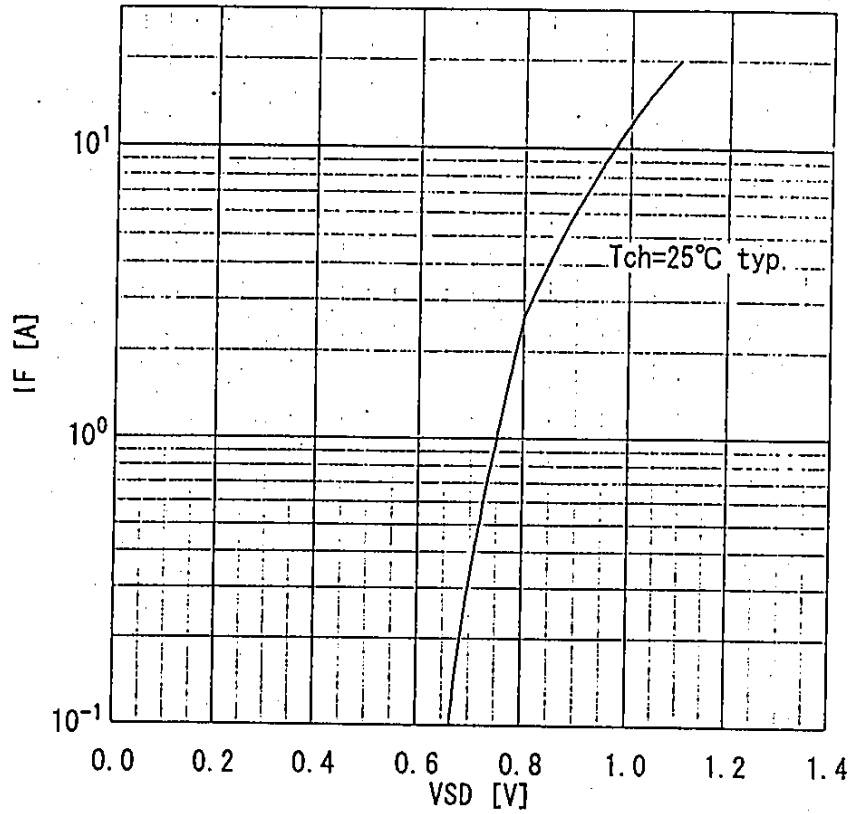

Transient thermal impedance
 $Z_{thch} = f(t)$ parameter: $D = t/T$

