

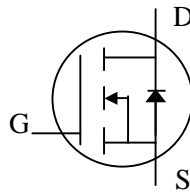

N-channel Enhancement-mode Power MOSFET

- Simple Drive Requirement
- Fast Switching Characteristics
- Low Gate Charge
- RoHS-compliant, halogen-free



BV_{DSS}	30V
$R_{DS(ON)}$	9mΩ
I_D	60A

Description

Advanced Power MOSFETs from APEC provide the designer with the best combination of fast switching, low on-resistance and cost-effectiveness.

The AP70T03AGH-HF-3 is in the TO-252 package which is widely preferred for commercial and industrial surface mount applications such as medium-power DC/DC converters. The through-hole TO-251 version (AP70T03AGJ-HF-3) is available where a small PCB footprint is required.

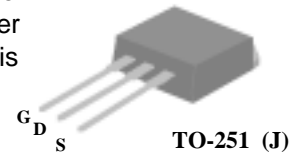

Absolute Maximum Ratings

Symbol	Parameter	Rating	Units
V_{DS}	Drain-Source Voltage	30	V
V_{GS}	Gate-Source Voltage	±20	V
I_D at $T_C=25^\circ C$	Continuous Drain Current ³	60	A
I_D at $T_C=100^\circ C$	Continuous Drain Current ³	43	A
I_{DM}	Pulsed Drain Current ¹	195	A
P_D at $T_C=25^\circ C$	Total Power Dissipation	53	W
	Linear Derating Factor	0.36	W/°C
T_{STG}	Storage Temperature Range	-55 to 175	°C
T_J	Operating Junction Temperature Range	-55 to 175	°C

Thermal Data

Symbol	Parameter	Value	Unit
Rthj-c	Maximum Thermal Resistance, Junction-case	2.8	°C/W
Rthj-a	Maximum Thermal Resistance, Junction-ambient(PCB mount) ³	62.5	°C/W
Rthj-a	Maximum Thermal Resistance, Junction-ambient	110	°C/W

Ordering Information

- AP70T03AGH-HF-3TR RoHS-compliant halogen-free TO-252 shipped on tape and reel (3000 pcs/reel)
- AP70T03AGJ-HF-3TB RoHS-compliant halogen-free TO-251 shipped in tubes (80pcs/tube)



Electrical Specifications at $T_j=25^\circ\text{C}$ (unless otherwise specified)

Symbol	Parameter	Test Conditions	Min.	Typ.	Max.	Units
BV_{DSS}	Drain-Source Breakdown Voltage	$V_{GS}=0V, I_D=250\mu A$	30	-	-	V
$\Delta BV_{DSS}/\Delta T_j$	Breakdown Voltage Temperature Coefficient	Reference to $25^\circ\text{C}, I_D=1\text{mA}$	-	0.032	-	$V/^\circ\text{C}$
$R_{DS(ON)}$	Static Drain-Source On-Resistance ²	$V_{GS}=10V, I_D=33A$	-	-	9	$m\Omega$
		$V_{GS}=4.5V, I_D=20A$	-	-	18	$m\Omega$
$V_{GS(th)}$	Gate Threshold Voltage	$V_{DS}=V_{GS}, I_D=250\mu A$	1	-	3	V
g_{fs}		$V_{DS}=10V, I_D=33A$	-	35	-	S
I_{DSS}	Drain-Source Leakage Current	$V_{DS}=30V, V_{GS}=0V$	-	-	1	μA
	Drain-Source Leakage Current ($T_j=125^\circ\text{C}$)	$V_{DS}=24V, V_{GS}=0V$	-	-	250	μA
I_{GSS}	Gate-Source Leakage	$V_{GS}=\pm 20V, V_{DS}=0V$	-	-	± 100	nA
Q_g	Total Gate Charge ²	$I_D=33A$	-	16.5	-	nC
Q_{gs}	Gate-Source Charge	$V_{DS}=20V$	-	5	-	nC
Q_{gd}	Gate-Drain ("Miller") Charge	$V_{GS}=4.5V$	-	10.3	-	nC
$t_{d(on)}$	Turn-on Delay Time ²	$V_{DS}=15V$	-	8.2	-	ns
t_r	Rise Time	$I_D=33A$	-	105	-	ns
$t_{d(off)}$	Turn-off Delay Time	$R_G=3.3\Omega, V_{GS}=10V$	-	21.4	-	ns
t_f	Fall Time	$R_D=0.45\Omega$	-	8.5	-	ns
C_{iss}	Input Capacitance	$V_{GS}=0V$	-	1485	-	pF
C_{oss}	Output Capacitance	$V_{DS}=25V$	-	245	-	pF
C_{riss}	Reverse Transfer Capacitance	$f=1.0\text{MHz}$	-	170	-	pF

Source-Drain Diode

Symbol	Parameter	Test Conditions	Min.	Typ.	Max.	Units
I_S	Continuous Source Current (Body Diode)	$V_D=V_G=0V, V_S=1.3V$	-	-	60	A
I_{SM}	Pulsed Source Current (Body Diode) ¹		-	-	195	A
V_{SD}	Forward On Voltage ²	$T_j=25^\circ\text{C}, I_S=60A, V_{GS}=0V$	-	-	1.3	V

Notes:

1. Pulse width limited by maximum junction temperature.
2. Pulse test - pulse width $\leq 300\mu s$, duty cycle $\leq 2\%$
3. Surface mounted on 1 in² copper pad of FR4 board,

THIS PRODUCT IS SENSITIVE TO ELECTROSTATIC DISCHARGE, PLEASE HANDLE WITH CAUTION.

USE OF THIS PRODUCT AS A CRITICAL COMPONENT IN LIFE SUPPORT OR OTHER SIMILAR SYSTEMS IS NOT AUTHORIZED.

APEC DOES NOT ASSUME ANY LIABILITY ARISING OUT OF THE APPLICATION OR USE OF ANY PRODUCT OR CIRCUIT DESCRIBED HEREIN; NEITHER DOES IT CONVEY ANY LICENSE UNDER ITS PATENT RIGHTS, NOR THE RIGHTS OF OTHERS.

APEC RESERVES THE RIGHT TO MAKE CHANGES WITHOUT FURTHER NOTICE TO ANY PRODUCTS HEREIN TO IMPROVE RELIABILITY, FUNCTION OR DESIGN.



Typical Electrical Characteristics

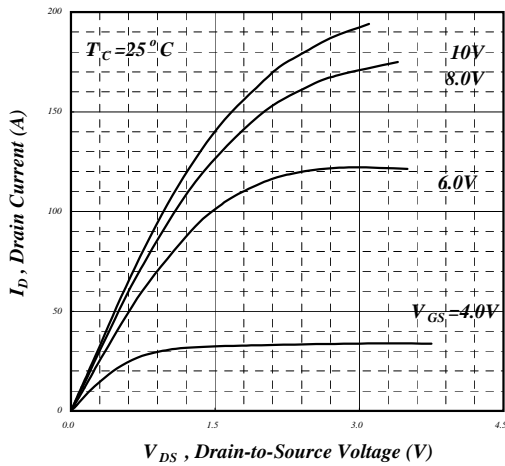

Fig 1. Typical Output Characteristics

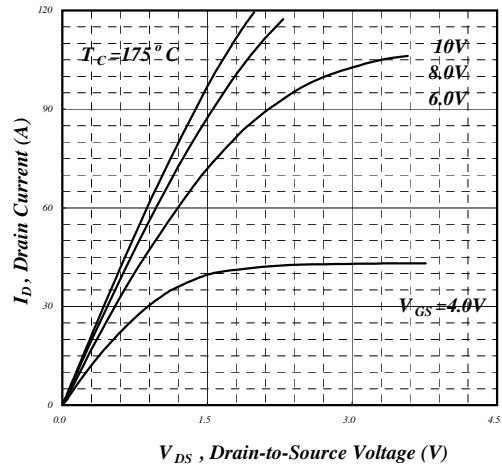

Fig 2. Typical Output Characteristics

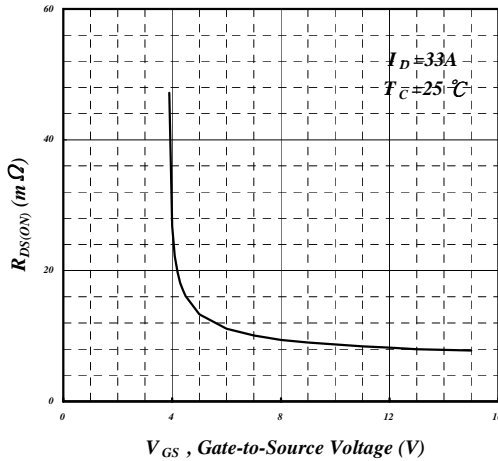

Fig 3. On-Resistance vs. Gate Voltage

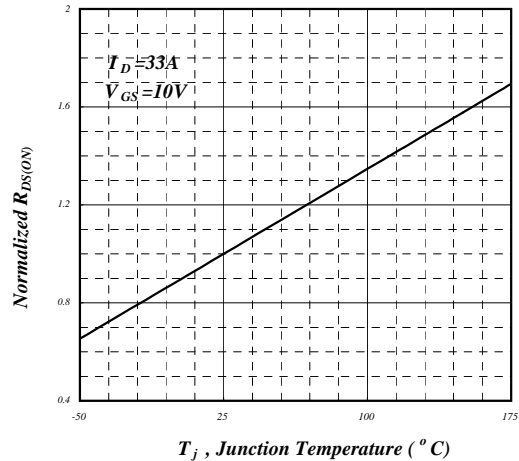

Fig 4. Normalized On-Resistance vs. Junction Temperature

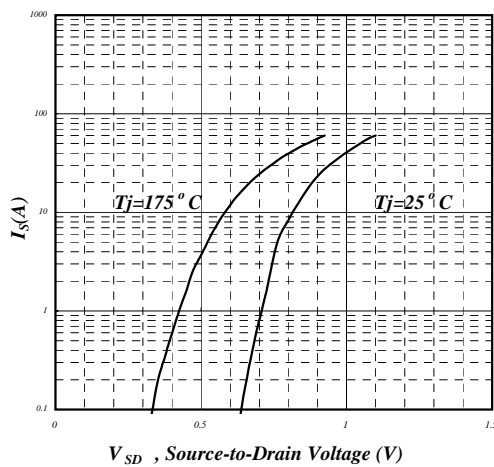

Fig 5. Forward Characteristic of Reverse Diode

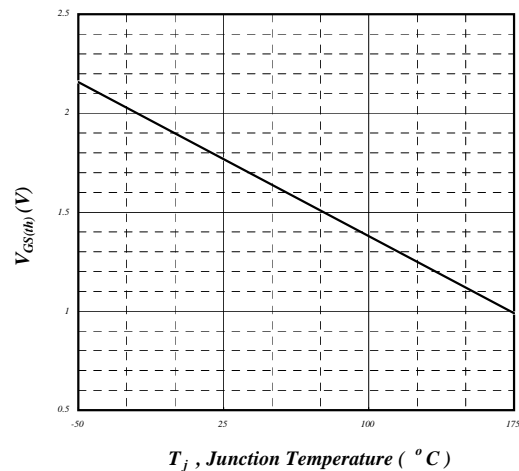

Fig 6. Gate Threshold Voltage vs. Junction Temperature



Typical Electrical Characteristics (cont.)

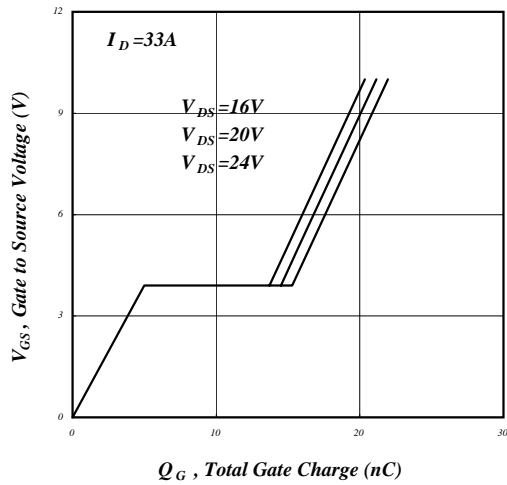

Fig 7. Gate Charge Characteristics

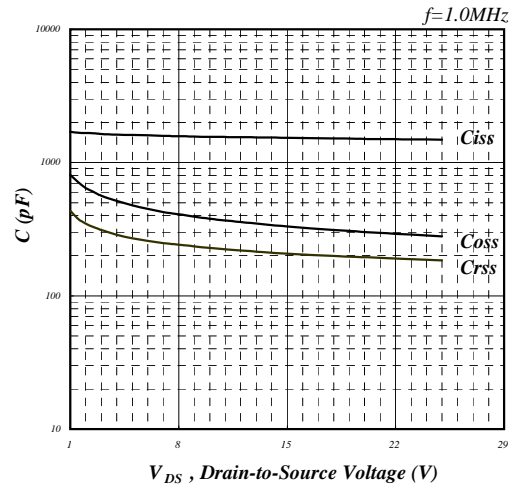

Fig 8. Typical Capacitance Characteristics

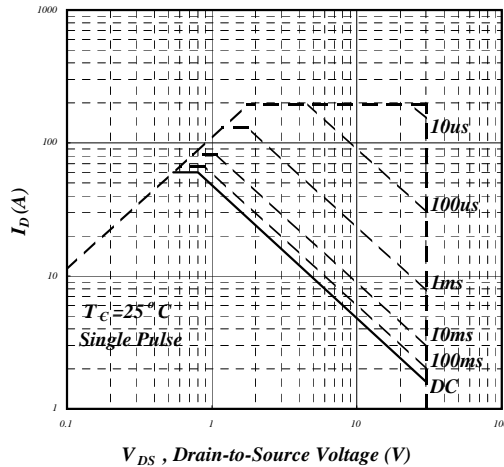

Fig 9. Maximum Safe Operating Area

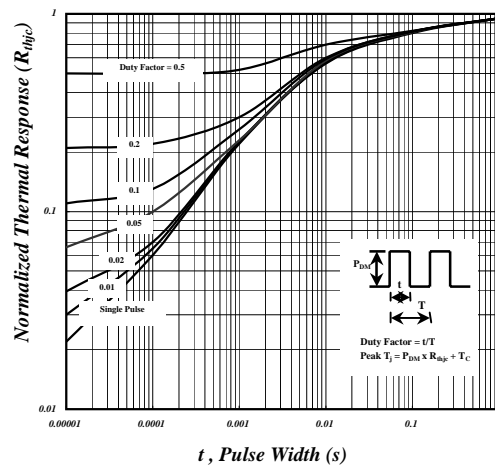

Fig 10. Effective Transient Thermal Impedance

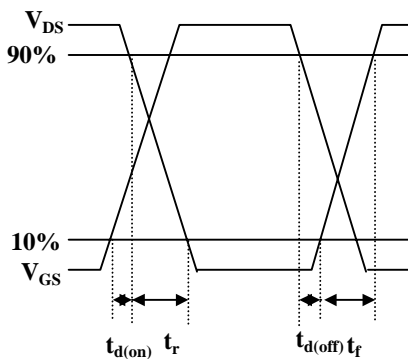

Fig 11. Switching Time Waveforms

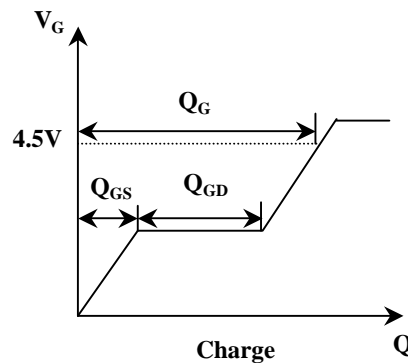
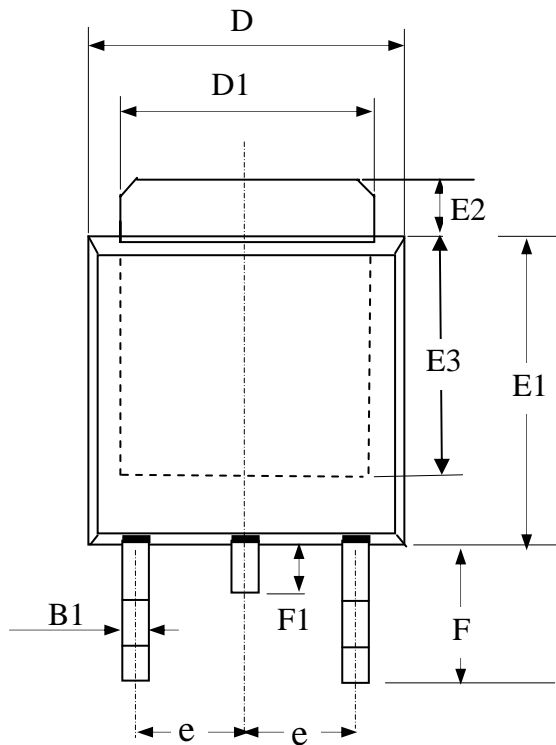

Fig 12. Gate Charge Waveform



Package Dimensions: TO-252



SYMBOLS	Millimeters		
	MIN	NOM	MAX
A2	1.80	2.30	2.80
A3	0.40	0.50	0.60
B1	0.40	0.70	1.00
D	6.00	6.50	7.00
D1	4.80	5.35	5.90
E3	3.50	4.00	4.50
F	2.20	2.63	3.05
F1	0.50	0.85	1.20
E1	5.10	5.70	6.30
E2	0.50	1.10	1.80
e	--	2.30	--
C	0.35	0.50	0.65

1. All dimensions are in millimeters.
2. Dimensions do not include mold protrusions.

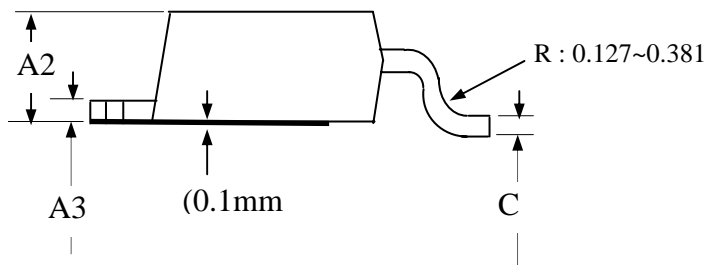

Marking Information: TO-252

Laser Marking

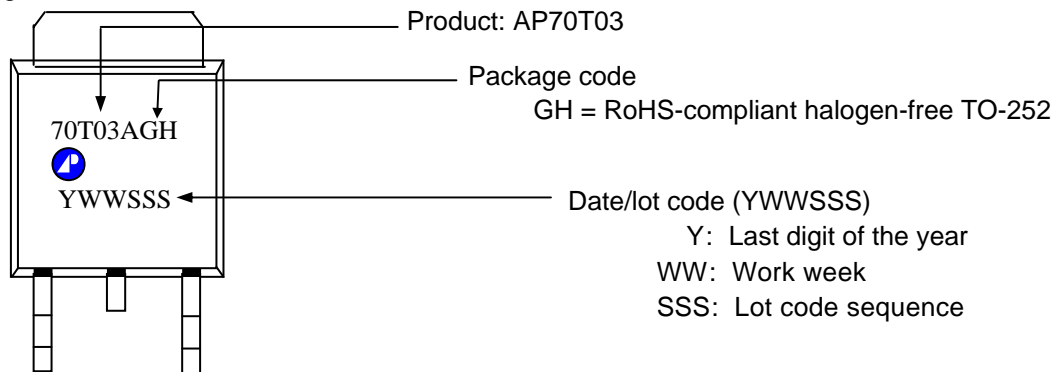



Package Dimensions: TO-251

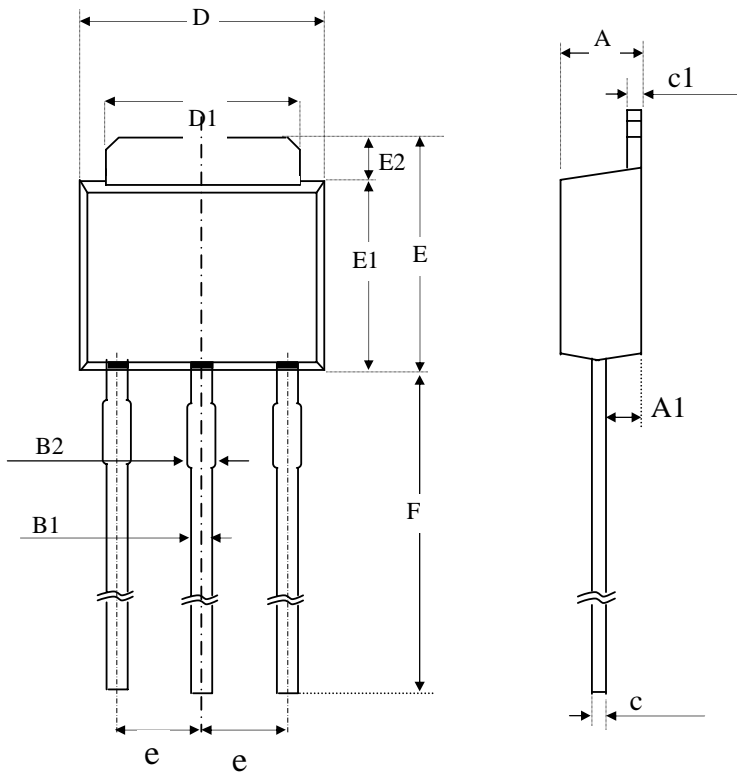

SYMBOLS	Millimeters		
	MIN	NOM	MAX
A	2.20	2.30	2.40
A1	0.90	1.20	1.50
B1	0.40	0.60	0.80
B2	0.60	0.85	1.05
c	0.40	0.50	0.60
c1	0.40	0.50	0.60
D	6.40	6.60	6.80
D1	4.80	5.20	5.50
E	6.70	7.00	7.30
E1	5.40	5.60	5.80
E2	1.30	1.50	1.70
e	----	2.30	----
F	7.00	8.30	9.60

1. All dimensions are in millimeters.
2. Dimensions do not include mold protrusions.

Marking Information: TO-251

