

FS3KM-18A

HIGH-SPEED SWITCHING USE

FS3KM-18A



- V_{DSS} 900V
- $r_{DS(ON)}(MAX)$ 4.0Ω
- I_D 3A
- V_{iso} 2000V

OUTLINE DRAWING Dimensions in mm

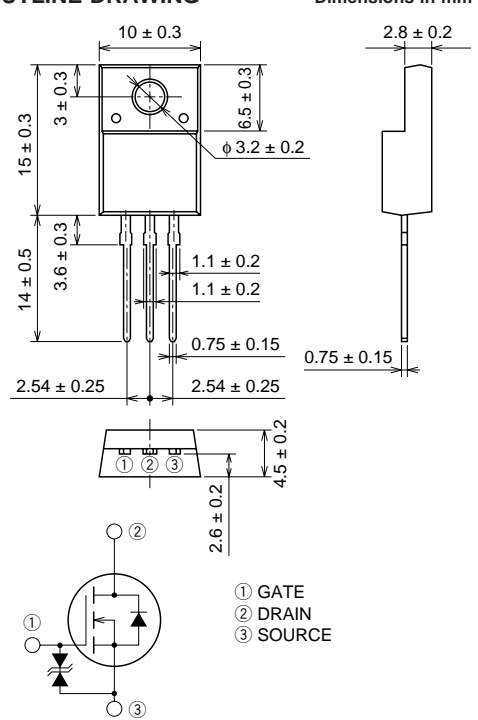

① GATE
② DRAIN
③ SOURCE

TO-220FN

APPLICATION

SMPS, DC-DC Converter, battery charger, power supply of printer, copier, HDD, FDD, TV, VCR, personal computer etc.

MAXIMUM RATINGS (Tc = 25°C)

Symbol	Parameter	Conditions	Ratings	Unit
V_{DSS}	Drain-source voltage	$V_{GS} = 0V$	900	V
V_{GSS}	Gate-source voltage	$V_{DS} = 0V$	± 30	V
I_D	Drain current		3	A
I_{DM}	Drain current (Pulsed)		9	A
P_D	Maximum power dissipation		30	W
T_{ch}	Channel temperature		-55 ~ +150	°C
T_{stg}	Storage temperature		-55 ~ +150	°C
V_{iso}	Isolation voltage	AC for 1minute, Terminal to case	2000	V_{rms}
—	Weight	Typical value	2	g

FS3KM-18A

HIGH-SPEED SWITCHING USE

ELECTRICAL CHARACTERISTICS (T_{ch} = 25°C)

Symbol	Parameter	Test conditions	Limits			Unit
			Min.	Typ.	Max.	
V (BR) DSS	Drain-source breakdown voltage	I _D = 1mA, V _{GS} = 0V	900	—	—	V
V (BR) GSS	Gate-source breakdown voltage	I _{GS} = ±100μA, V _{DS} = 0V	±30	—	—	V
I _{GSS}	Gate-source leakage current	V _{GS} = ±25V, V _{DS} = 0V	—	—	±10	μA
I _{DSS}	Drain-source leakage current	V _{DS} = 900V, V _{GS} = 0V	—	—	1	mA
V _{GS(th)}	Gate-source threshold voltage	I _D = 1mA, V _{DS} = 10V	2	3	4	V
r _{DS(ON)}	Drain-source on-state resistance	I _D = 1.5A, V _{GS} = 10V	—	3.08	4.00	Ω
V _{DS(ON)}	Drain-source on-state voltage	I _D = 1.5A, V _{GS} = 10V	—	4.62	6.00	V
y _{fs}	Forward transfer admittance	I _D = 1.5A, V _{DS} = 10V	2.1	3.5	—	S
C _{iss}	Input capacitance	V _{DS} = 25V, V _{GS} = 0V, f = 1MHz	—	770	—	pF
C _{oss}	Output capacitance		—	77	—	pF
C _{rss}	Reverse transfer capacitance		—	13	—	pF
t _{d(on)}	Turn-on delay time	V _{DD} = 200V, I _D = 1.5A, V _{GS} = 10V, R _{GEN} = R _{GS} = 50Ω	—	15	—	ns
t _r	Rise time		—	15	—	ns
t _{d(off)}	Turn-off delay time		—	90	—	ns
t _f	Fall time		—	25	—	ns
V _{SD}	Source-drain voltage	I _S = 1.5A, V _{GS} = 0V	—	1.0	1.5	V
R _{th(ch-c)}	Thermal resistance	Channel to case	—	—	4.17	°C/W

PERFORMANCE CURVES

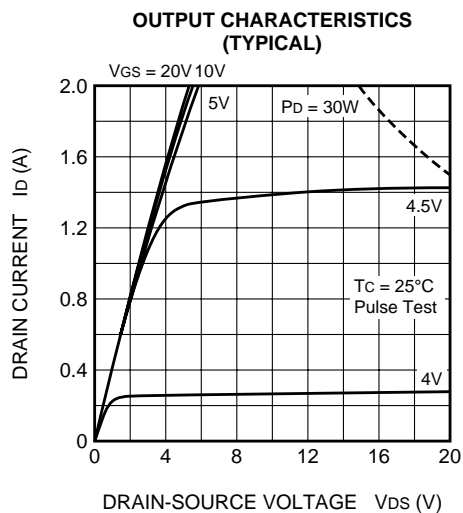
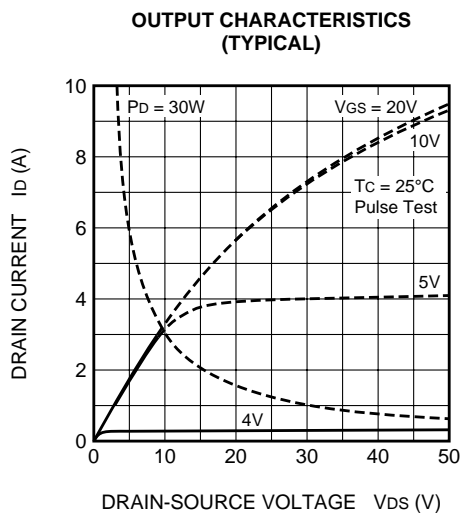
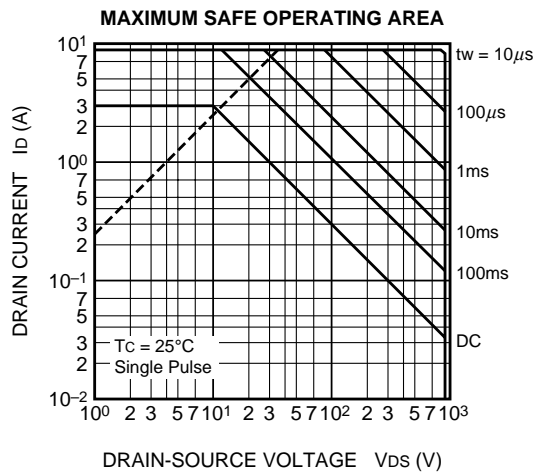
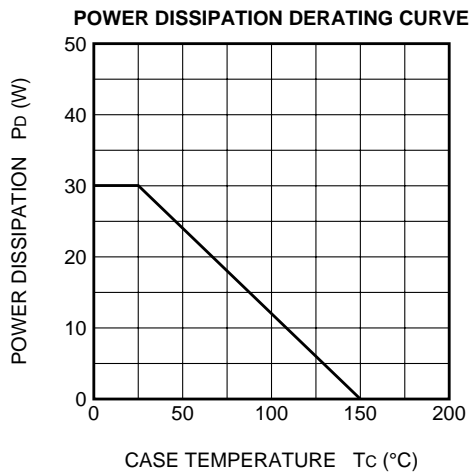

FS3KM-18A

HIGH-SPEED SWITCHING USE

ON-STATE VOLTAGE VS. GATE-SOURCE VOLTAGE (TYPICAL)

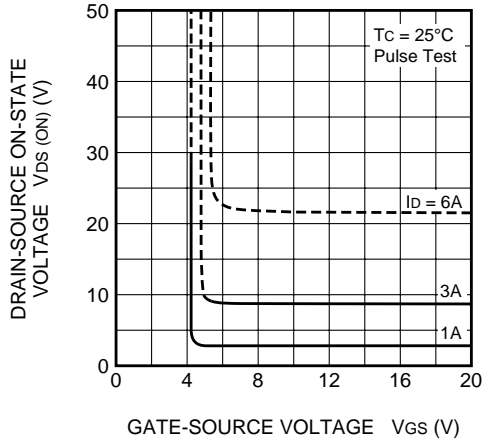

ON-STATE RESISTANCE VS. DRAIN CURRENT (TYPICAL)

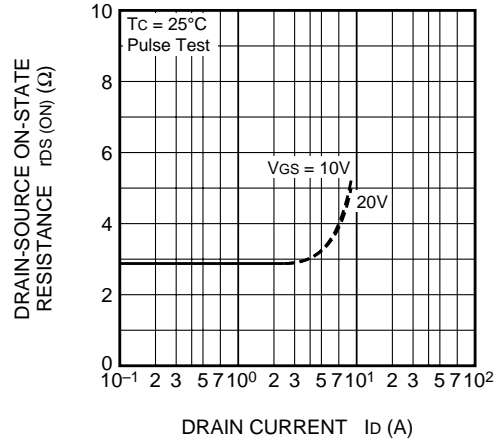

TRANSFER CHARACTERISTICS (TYPICAL)

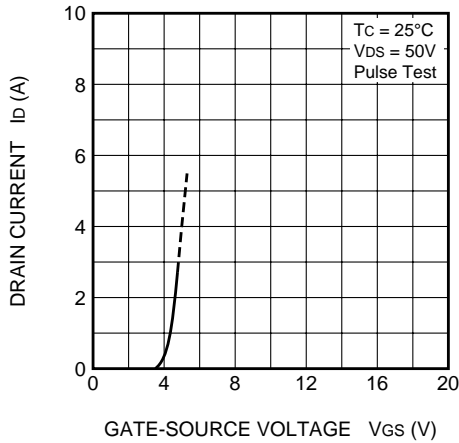

FORWARD TRANSFER ADMITTANCE VS. DRAIN CURRENT (TYPICAL)

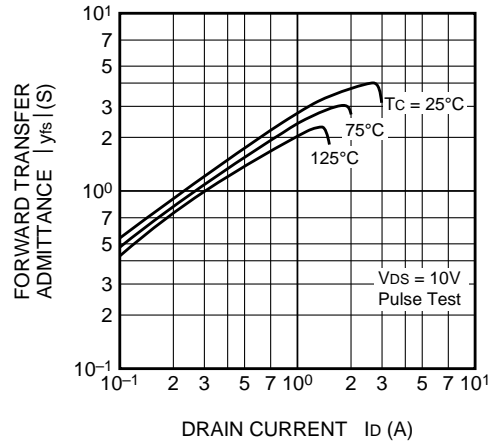

CAPACITANCE VS. DRAIN-SOURCE VOLTAGE (TYPICAL)

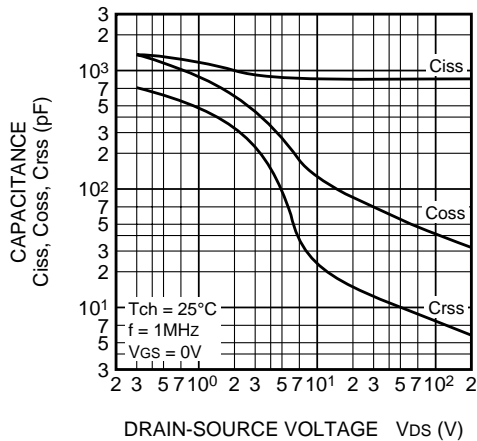

SWITCHING CHARACTERISTICS (TYPICAL)

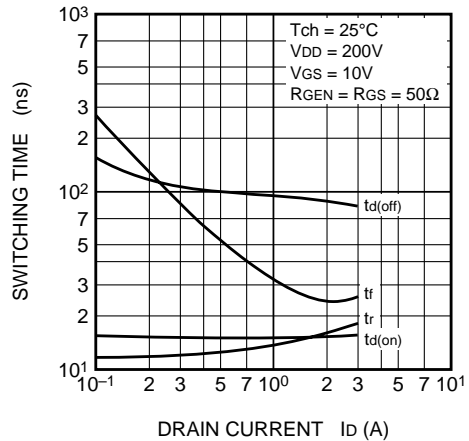

GATE-SOURCE VOLTAGE VS. GATE CHARGE (TYPICAL)

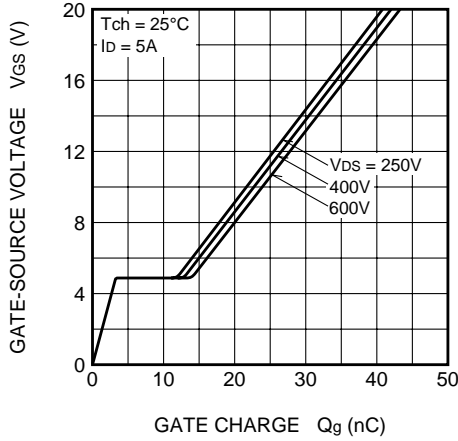

SOURCE-DRAIN DIODE FORWARD CHARACTERISTICS (TYPICAL)

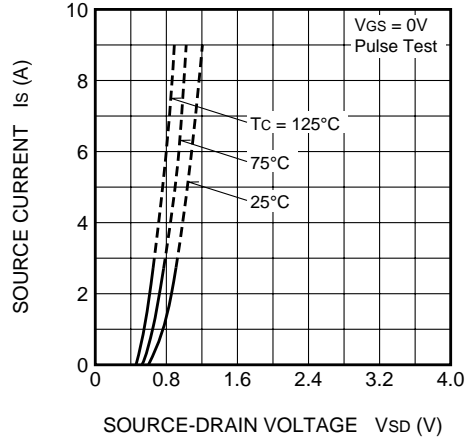

ON-STATE RESISTANCE VS. CHANNEL TEMPERATURE (TYPICAL)

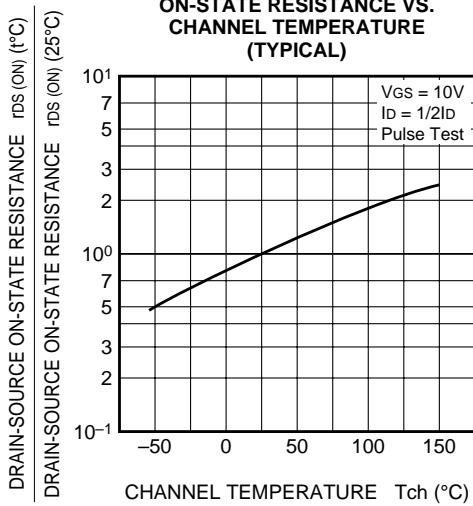

THRESHOLD VOLTAGE VS. CHANNEL TEMPERATURE (TYPICAL)

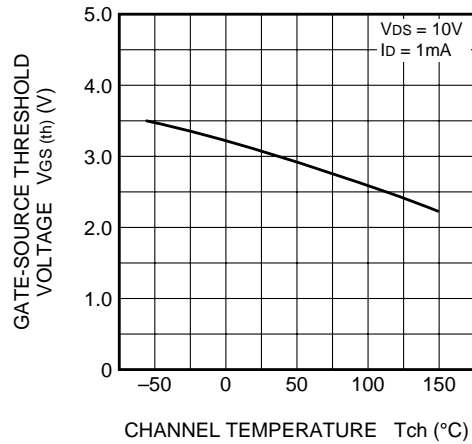

BREAKDOWN VOLTAGE VS. CHANNEL TEMPERATURE (TYPICAL)

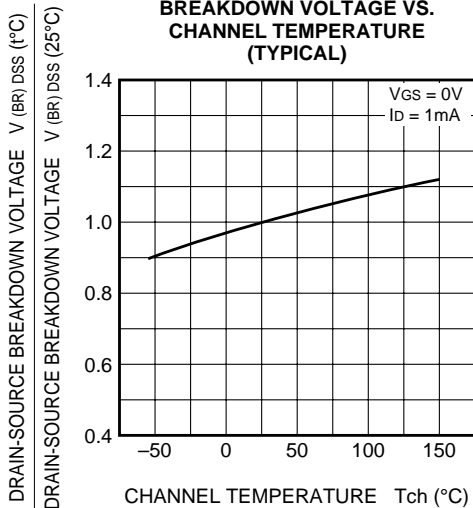

TRANSIENT THERMAL IMPEDANCE CHARACTERISTICS

