

HEXFET® Power MOSFET

V_{DSS}	30	V
$R_{DS(on) \max}$	1.10	mΩ
Q_g (typical)	58	nC
R_G (typical)	1.0	Ω
I_D (@ T_C (Bottom) = 25°C)	100Ⓞ	A

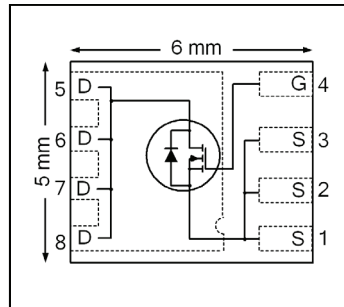

Applications

- Control MOSFET for synchronous buck converter

Features

Low $R_{DS(ON)}$ (≤ 1.10 mΩ)
Low Thermal Resistance to PCB ($<0.8^\circ\text{C/W}$)
100% Rg Tested
Low Profile (≤ 0.9 mm)
Industry-Standard Pinout
Compatible with Existing Surface Mount Techniques
RoHS Compliant, Halogen-Free
MSL1, Industrial Qualification

results in
⇒

Benefits

Lower Conduction Losses
Enable better Thermal Dissipation
Increased Reliability
Increased Power Density
Multi-Vendor Compatibility
Easier Manufacturing
Environmentally Friendlier
Increased Reliability

Base part number	Package Type	Standard Pack		Orderable Part Number
		Form	Quantity	
IRFH8303PbF	PQFN 5 mm x 6 mm	Tape and Reel	4000	IRFH8303TRPbF

Absolute Maximum Ratings

	Parameter	Max.	Units
V_{GS}	Gate-to-Source Voltage	± 20	V
I_D @ $T_A = 25^\circ\text{C}$	Continuous Drain Current, V_{GS} @ 10V	43	A
I_D @ $T_{C(Bottom)} = 25^\circ\text{C}$	Continuous Drain Current, V_{GS} @ 10V	280ⓄⓈ	
I_D @ $T_{C(Bottom)} = 100^\circ\text{C}$	Continuous Drain Current, V_{GS} @ 10V	177ⓄⓈ	
I_D @ $T_C = 25^\circ\text{C}$	Continuous Drain Current, V_{GS} @ 10V (Source Bonding Technology Limited)	100Ⓞ	
I_{DM}	Pulsed Drain Current	400	
P_D @ $T_A = 25^\circ\text{C}$	Power Dissipation	3.7	W
P_D @ $T_{C(Bottom)} = 25^\circ\text{C}$	Power Dissipation	156	
	Linear Derating Factor	0.029	W/°C
T_J T_{STG}	Operating Junction and Storage Temperature Range	-55 to + 150	°C

Notes ① through ⑦ are on page 8

Static @ T_J = 25°C (unless otherwise specified)

	Parameter	Min.	Typ.	Max.	Units	Conditions
BV _{DSS}	Drain-to-Source Breakdown Voltage	30	—	—	V	V _{GS} = 0V, I _D = 250μA
ΔBV _{DSS} /ΔT _J	Breakdown Voltage Temp. Coefficient	—	21	—	mV/°C	Reference to 25°C, I _D = 1.0mA
R _{DS(on)}	Static Drain-to-Source On-Resistance	—	0.90	1.10	mΩ	V _{GS} = 10V, I _D = 50A ②
		—	1.30	1.70		V _{GS} = 4.5V, I _D = 50A ②
V _{GS(th)}	Gate Threshold Voltage	1.2	1.7	2.2	V	V _{DS} = V _{GS} , I _D = 150μA
ΔV _{GS(th)}	Gate Threshold Voltage Coefficient	—	-5.7	—	mV/°C	
I _{DSS}	Drain-to-Source Leakage Current	—	—	1.0	μA	V _{DS} = 24V, V _{GS} = 0V
		—	—	150		V _{DS} = 24V, V _{GS} = 0V, T _J = 125°C
I _{GSS}	Gate-to-Source Forward Leakage	—	—	100	nA	V _{GS} = 20 V
	Gate-to-Source Reverse Leakage	—	—	-100		V _{GS} = -20 V
g _{fs}	Forward Transconductance	158	—	—	S	V _{DS} = 15 V, I _D = 50A
Q _g	Total Gate Charge	—	119	179	nC	V _{GS} = 10V, V _{DS} = 15V, I _D = 50A
Q _{gs1}	Pre-V _{th} Gate-to-Source Charge	—	14	—		V _{DS} = 15V
Q _{gs2}	Post-V _{th} Gate-to-Source Charge	—	8	—		V _{GS} = 4.5V
Q _{gd}	Gate-to-Drain Charge	—	19	—		I _D = 50A
Q _{godr}	Gate Charge Overdrive	—	17	—		
Q _{sw}	Switch Charge (Q _{gs2} + Q _{gd})	—	27	—		
Q _{oss}	Output Charge	—	33	—		nC
R _G	Gate Resistance	—	1.0	—	Ω	
t _{d(on)}	Turn-On Delay Time	—	21	—	ns	V _{DD} = 30V, V _{GS} = 4.5V
t _r	Rise Time	—	91	—		I _D = 50A
t _{d(off)}	Turn-Off Delay Time	—	48	—		R _G = 1.8Ω
t _f	Fall Time	—	65	—		
C _{iss}	Input Capacitance	—	7736	—	pF	V _{GS} = 0V
C _{oss}	Output Capacitance	—	1363	—		V _{DS} = 24V
C _{rss}	Reverse Transfer Capacitance	—	743	—		f = 1.0MHz

Avalanche Characteristics

	Parameter	Typ.	Max.	Units
E _{AS}	Single Pulse Avalanche Energy ①	—	355	mJ

Diode Characteristics

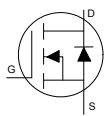
	Parameter	Min.	Typ.	Max.	Units	Conditions
I _S	Continuous Source Current (Body Diode)	—	—	100⑥	A	MOSFET symbol showing the integral reverse p-n junction diode. 
I _{SM}	Pulsed Source Current (Body Diode)	—	—	400		
V _{SD}	Diode Forward Voltage	—	—	1.0	V	T _J = 25°C, I _S = 50A, V _{GS} = 0V ②
t _{rr}	Reverse Recovery Time	—	33	50	ns	T _J = 25°C, I _F = 50A, V _{DD} = 15V
Q _{rr}	Reverse Recovery Charge	—	51	77	nC	di/dt = 200A/μs ②

Thermal Resistance

	Parameter	Typ.	Max.	Units
R _{θJC} (Bottom)	Junction-to-Case ③	—	0.8	°C/W
R _{θJC} (Top)	Junction-to-Case ③	—	21	
R _{θJA}	Junction-to-Ambient ④	—	34	
R _{θJA} (<10s)	Junction-to-Ambient ④	—	21	

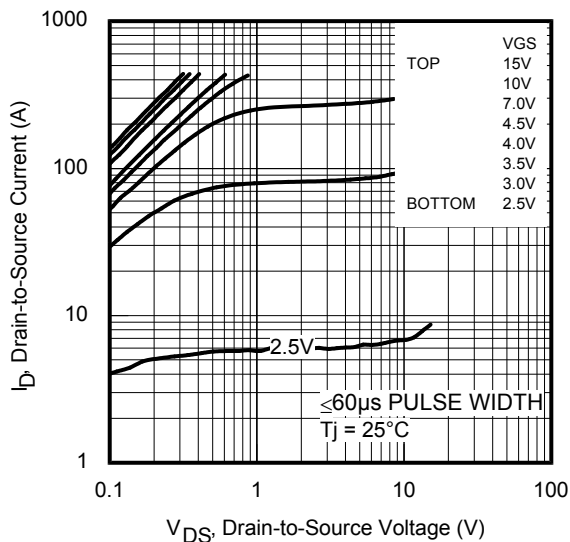
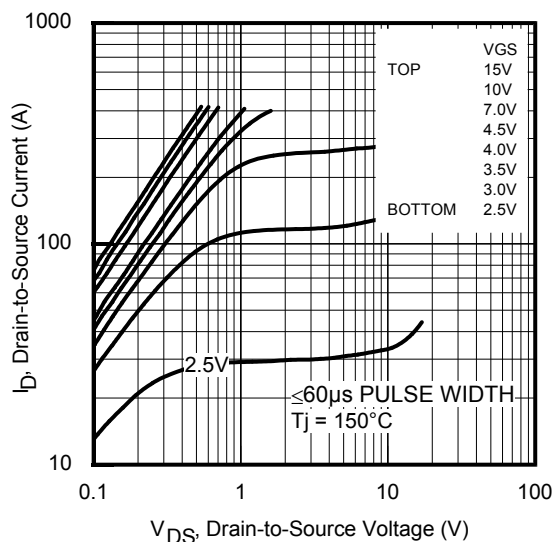
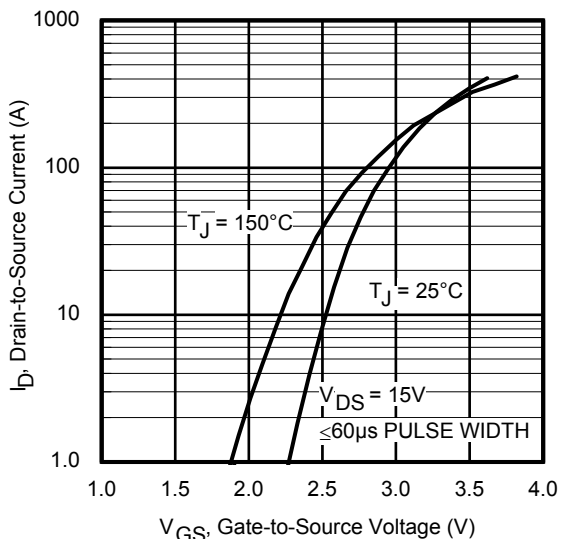
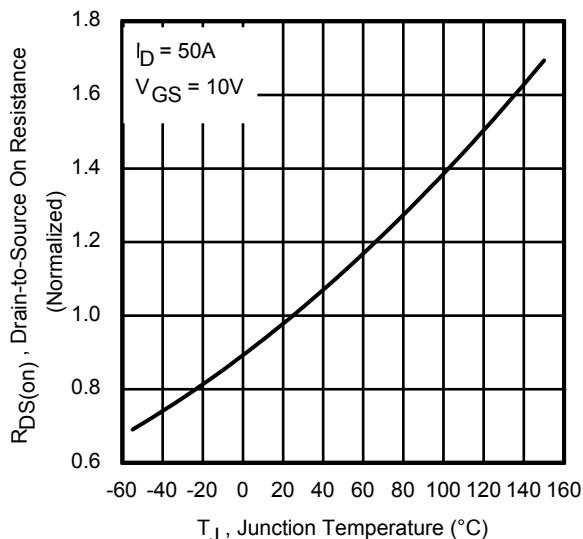
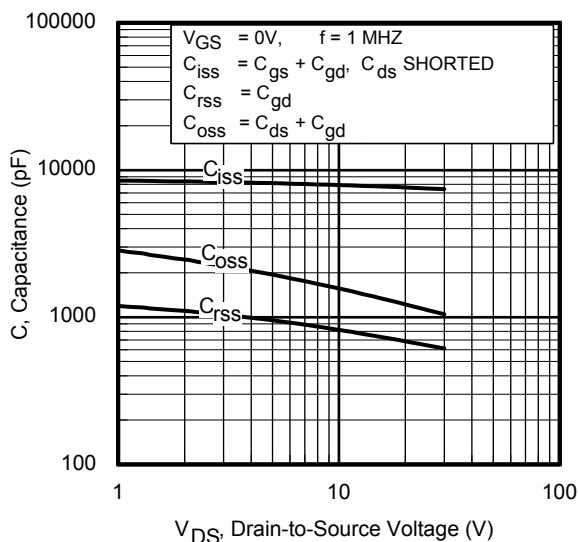
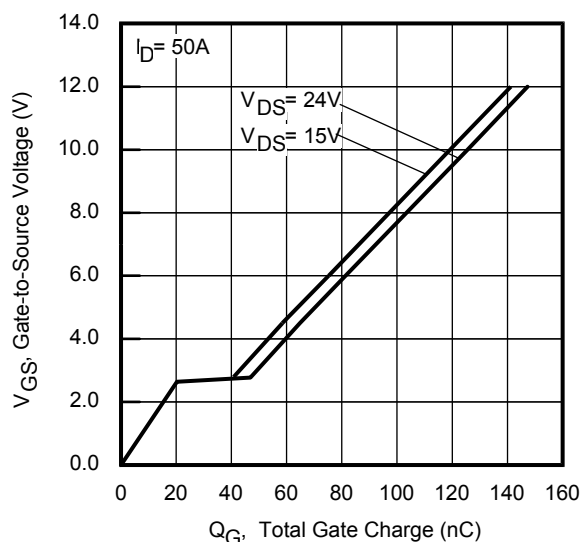
Fig 1. Typical Output Characteristics

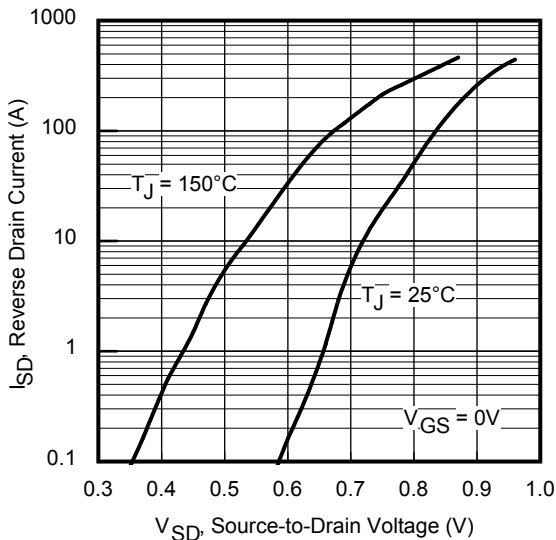
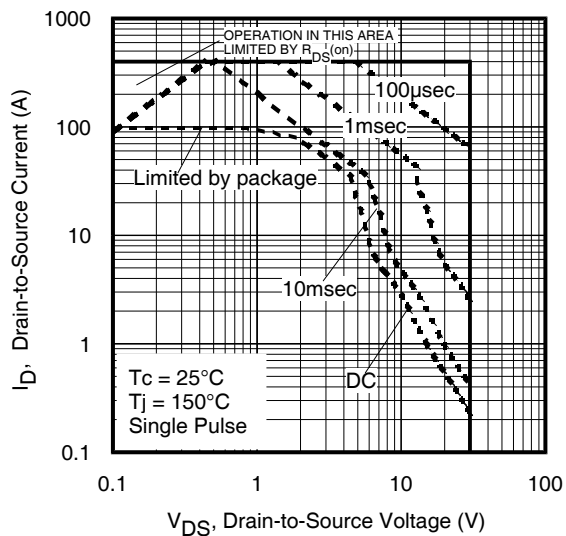
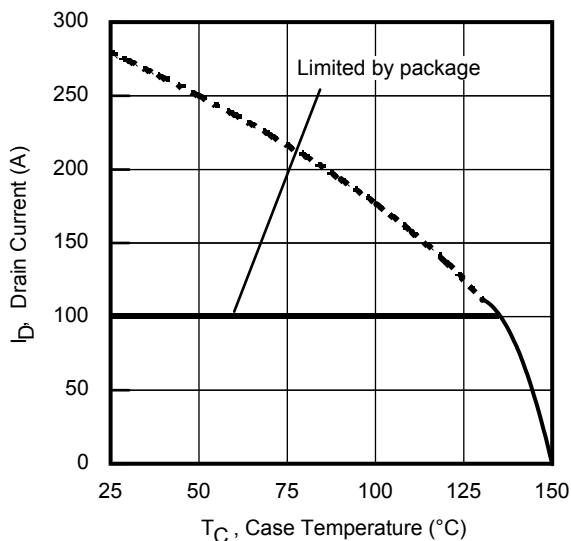
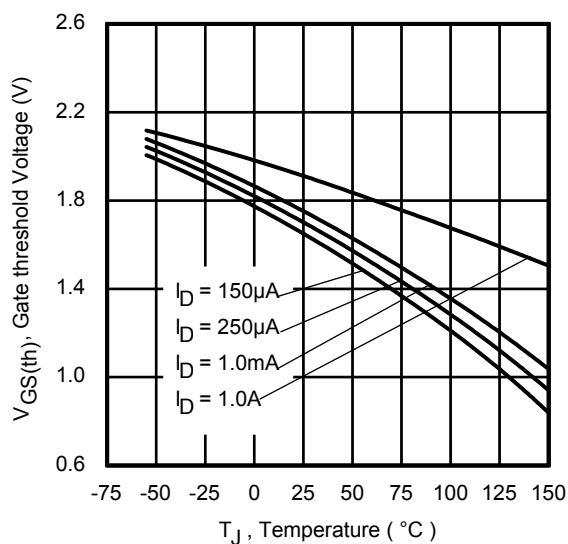
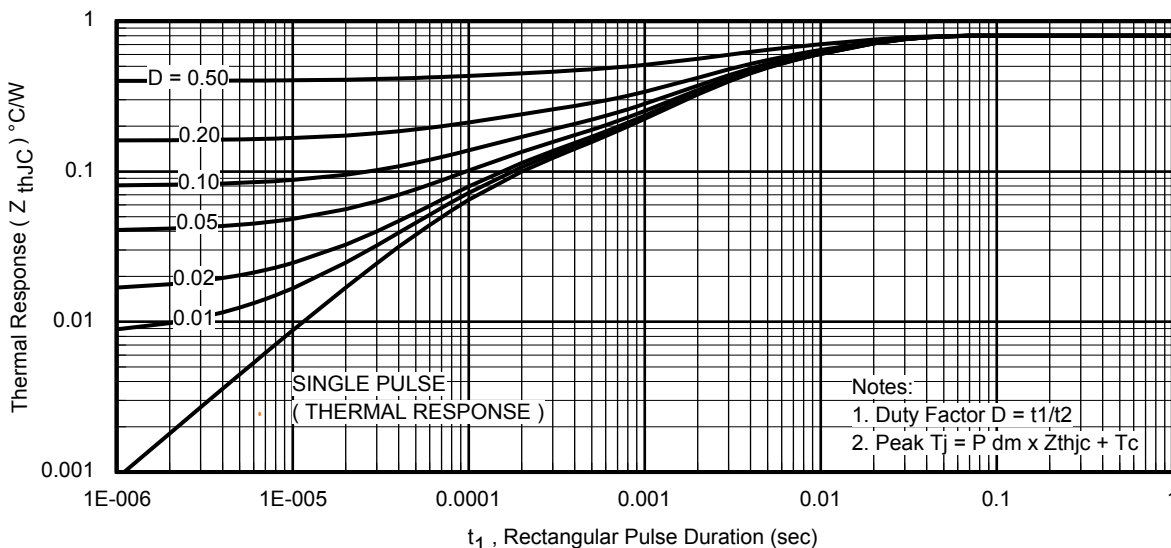
Fig 2. Typical Output Characteristics

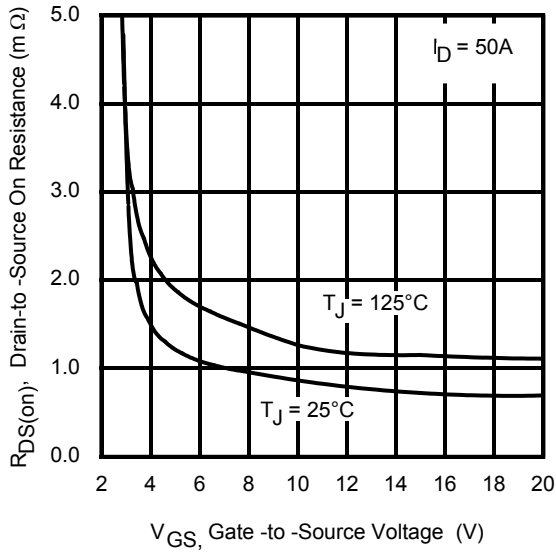
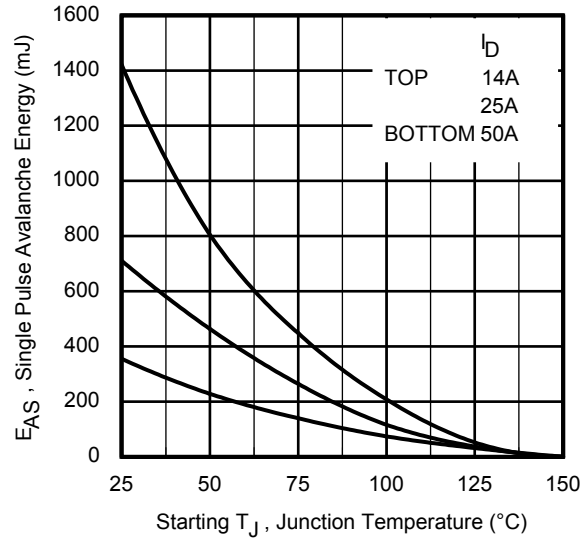
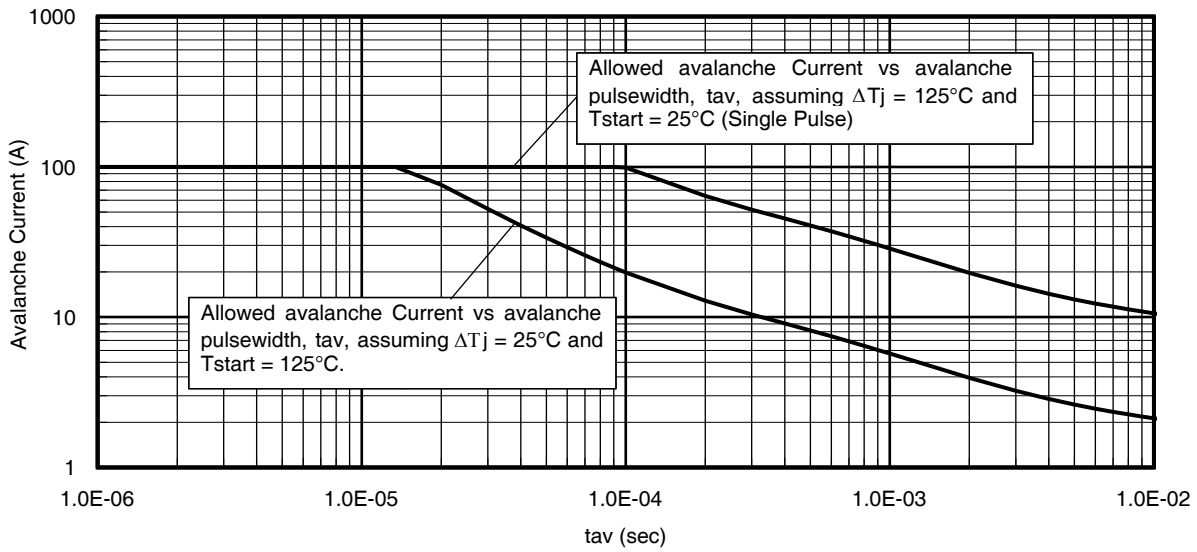
Fig 3. Typical Transfer Characteristics

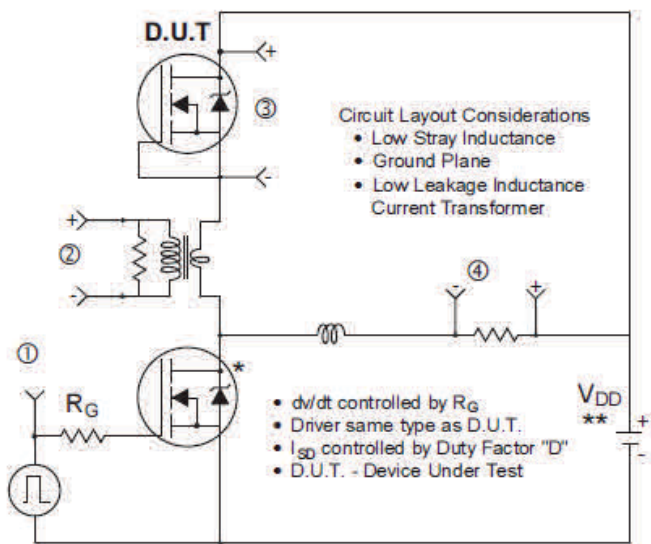
Fig 4. Normalized On-Resistance vs. Temperature

Fig 5. Typical Capacitance vs. Drain-to-Source Voltage

Fig 6. Typical Gate Charge vs. Gate-to-Source Voltage

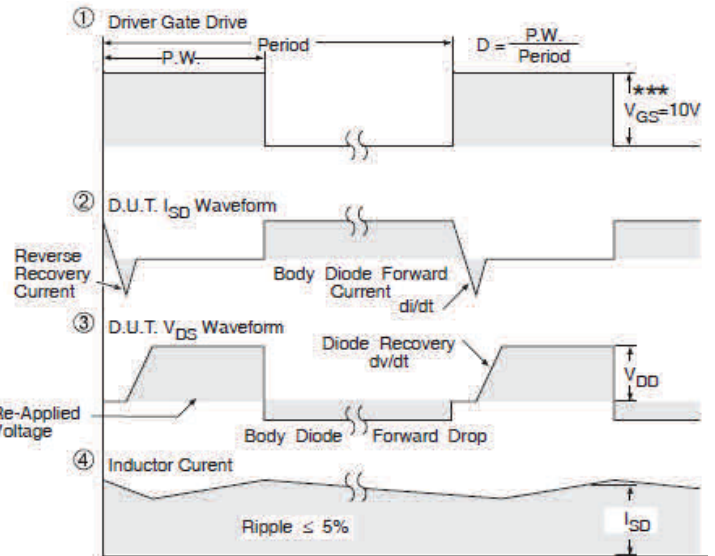

Fig 7. Typical Source-Drain Diode Forward Voltage

Fig 8. Maximum Safe Operating Area

Fig 9. Maximum Drain Current vs. Case Temperature

Fig 10. Drain-to-Source Breakdown Voltage

Fig 11. Maximum Effective Transient Thermal Impedance, Junction-to-Case

Fig 12. On-Resistance vs. Gate Voltage

Fig 13. Maximum Avalanche Energy vs. Drain Current

Fig 14. Single Avalanche Event: Pulse Current vs. Pulse Width



* Use P-Channel Driver for P-Channel Measurements
 ** Reverse Polarity for P-Channel

Fig 15. Peak Diode Recovery dv/dt Test Circuit for N-Channel HEXFET® Power MOSFETs



*** $V_{GS} = 5V$ for Logic Level Devices

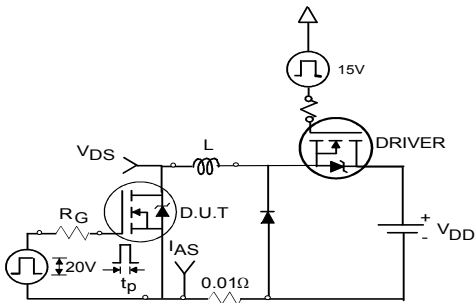

Fig 16a. Unclamped Inductive Test Circuit

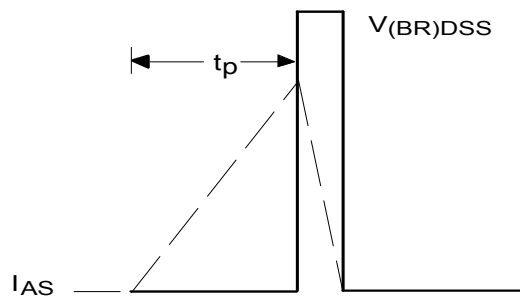

Fig 16b. Unclamped Inductive Waveforms

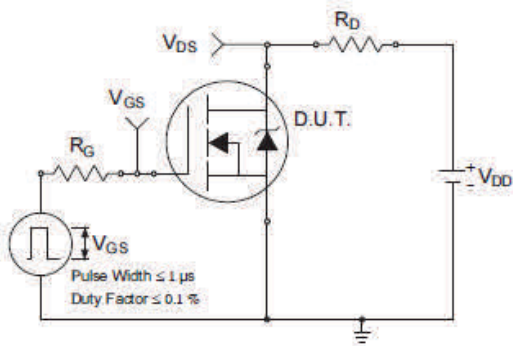

Fig 17a. Switching Time Test Circuit

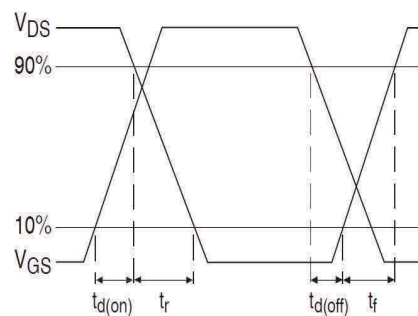

Fig 17b. Switching Time Waveforms

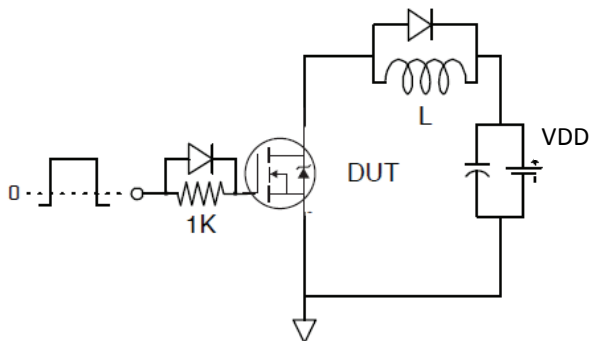

Fig 18. Gate Charge Test Circuit

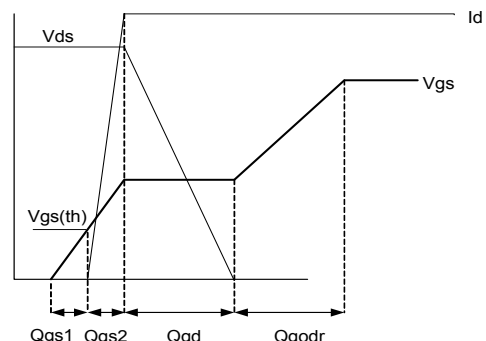
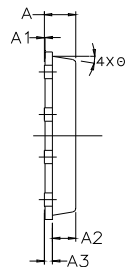
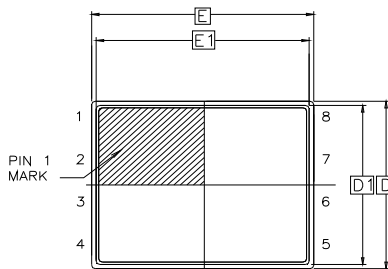

Fig 19. Gate Charge Waveform

PQFN 5x6 Outline "B" Package Details



SIDE VIEW



TOP VIEW

SYMBOL	DIM	MIN	NOM	MAX
A		0.800	0.830	1.05
A1		0.000	0.020	0.050
A2		0.580	0.630	0.680
A3		0.254 REF		
Ø		0"	10"	12"
b		0.350	0.400	0.470
D		4.850	5.000	5.150
D1		4.675	4.750	5.000
D2		3.700	4.210	4.300
e		1.270 BSC		
E		5.850	6.000	6.150
E1		5.675	5.750	6.000
E2		3.380	3.480	3.760
E4		2.480	2.580	2.680
L		0.550	0.800	0.900
R		0.200 REF		
R1		0.100 REF		
R2		0.150	0.200	0.250

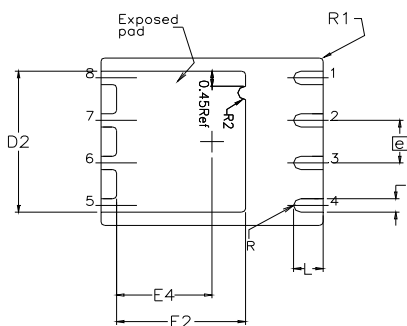

BOTTOM VIEW

For more information on board mounting, including footprint and stencil recommendation, please refer to application note AN-1136: <http://www.irf.com/technical-info/appnotes/an-1136.pdf>
 For more information on package inspection techniques, please refer to application note AN-1154: <http://www.irf.com/technical-info/appnotes/an-1154.pdf>

PQFN 5x6 Outline "B" Part Marking

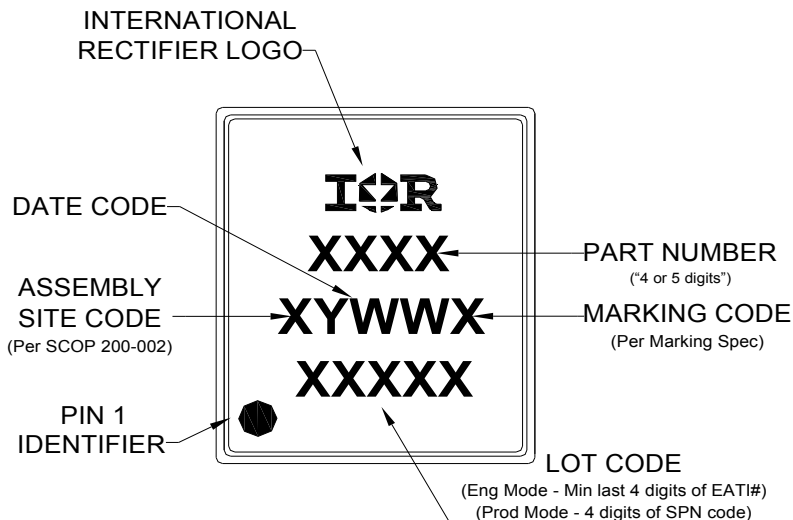

Note: For the most current drawing please refer to IR website at <http://www.irf.com/package/>

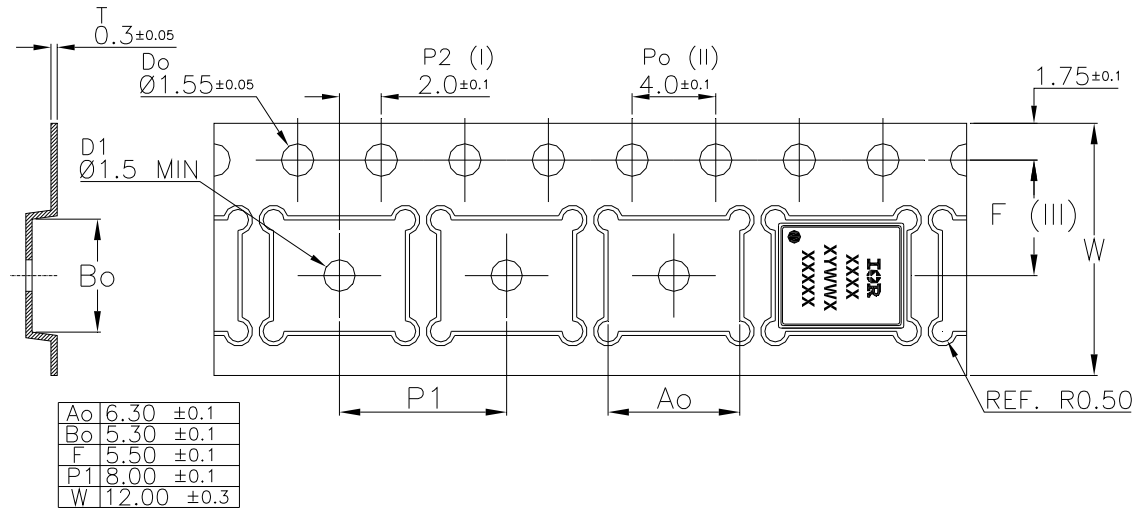
PQFN 5x6 Outline "B" Tape and Reel

Note: For the most current drawing please refer to IR website at <http://www.irf.com/package/>

Qualification Information†

Qualification Level	Industrial (per JEDEC JESD47F ^{††} guidelines)	
Moisture Sensitivity Level	PQFN 5mm x 6mm	MSL1 (per JEDEC J-STD-020D ^{††})
RoHS Compliant	Yes	

† Qualification standards can be found at International Rectifier's web site: <http://www.irf.com/product-info/reliability>

†† Applicable version of JEDEC standard at the time of product release.

Notes:

- ① Starting $T_J = 25^\circ\text{C}$, $L = 0.28\text{mH}$, $R_G = 50\Omega$, $I_{AS} = 50\text{A}$.
- ② Pulse width $\leq 400\mu\text{s}$; duty cycle $\leq 2\%$.
- ③ R_{θ} is measured at T_J of approximately 90°C .
- ④ When mounted on 1 inch square PCB (FR-4). Please refer to AN-994 for more details: <http://www.irf.com/technical-info/appnotes/an-994.pdf>
- ⑤ Calculated continuous current based on maximum allowable junction temperature.
- ⑥ Current is limited to 100A by source bonding technology.

Revision History

Date	Comments
10/22/2013	• Added the $R_{ds(on)}$ at $V_{gs} = 4.5\text{V}$ values, on page 2.