

MOSFET

Metal Oxide Semiconductor Field Effect Transistor

OptiMOS™ Power-Transistor, 100V

OptiMOS™ 3 Power Transistor
BSZ160N10NS3

Data Sheet

Rev. 2.1
Final

OptiMOS™3 Power-Transistor
Features

- Ideal for high frequency switching
- Optimized technology for DC/DC converters
- Excellent gate charge x $R_{DS(on)}$ product (FOM)
- N-channel, normal level
- 100% avalanche tested
- Pb-free plating; RoHS compliant
- Qualified according to JEDEC¹⁾ for target applications
- Halogen-free according to IEC61249-2-21



Type	Package	Marking
BSZ160N10NS3 G	PG-TSDSON-8	160N10N

Product Summary

V_{DS}	100	V
$R_{DS(on),max}$	16	m Ω
I_D	40	A

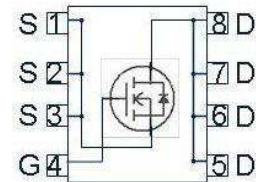
PG-TSDSON-8

Maximum ratings, at $T_A=25\text{ °C}$, unless otherwise specified

Parameter	Symbol	Conditions	Value	Unit
Continuous drain current	I_D	$V_{GS}=10\text{ V}, T_C=25\text{ °C}$	40	A
		$V_{GS}=10\text{ V}, T_C=100\text{ °C}$	28	
		$V_{GS}=10\text{ V}, T_A=25\text{ °C}, R_{thJA}=60\text{ K/W}^{2)}$	8	
Pulsed drain current ³⁾	$I_{D,pulse}$	$T_C=25\text{ °C}$	160	
Avalanche energy, single pulse ⁴⁾	E_{AS}	$I_D=20\text{ A}, R_{GS}=25\text{ }\Omega$	80	mJ
Gate source voltage	V_{GS}		± 20	V

¹⁾ J-STD20 and JESD22

²⁾ Device on 40 mm x 40 mm x 1.5 mm epoxy PCB FR4 with 6 cm² (one layer, 70 μm thick) copper area for drain connection. PCB is vertical in still air.

³⁾ See Diagram 3 for more detailed information

⁴⁾ See Diagram 13 for more detailed information

Maximum ratings, at $T_A=25\text{ °C}$, unless otherwise specified

Parameter	Symbol	Conditions	Value	Unit
Power dissipation	P_{tot}	$T_C=25\text{ °C}$	63	W
		$T_A=25\text{ °C}$, $R_{\text{thJA}}=60\text{ K/W}^2)$	2.1	
Operating and storage temperature	T_j, T_{stg}		-55 ... 150	°C
IEC climatic category; DIN IEC 68-1			55/150/56	

Parameter	Symbol	Conditions	Values			Unit
			min.	typ.	max.	

Thermal characteristics

Thermal resistance, junction - case	R_{thJC}		-	-	2.1	K/W
Device on PCB	R_{thJA}	minimal footprint	-	-	62	
		6 cm ² cooling area ²⁾	-	-	60	

Electrical characteristics, at $T_j=25\text{ °C}$, unless otherwise specified

Static characteristics

Drain-source breakdown voltage	$V_{(\text{BR})\text{DSS}}$	$V_{\text{GS}}=0\text{ V}, I_{\text{D}}=1\text{ mA}$	100	-	-	V
Gate threshold voltage	$V_{\text{GS(th)}}$	$V_{\text{DS}}=V_{\text{GS}}, I_{\text{D}}=33\text{ }\mu\text{A}$	2	2.8	3.5	
Zero gate voltage drain current	I_{DSS}	$V_{\text{DS}}=100\text{ V}, V_{\text{GS}}=0\text{ V}, T_j=25\text{ °C}$	-	0.1	1	μA
		$V_{\text{DS}}=100\text{ V}, V_{\text{GS}}=0\text{ V}, T_j=125\text{ °C}$	-	10	100	
Gate-source leakage current	I_{GSS}	$V_{\text{GS}}=20\text{ V}, V_{\text{DS}}=0\text{ V}$	-	10	100	nA
Drain-source on-state resistance	$R_{\text{DS(on)}}$	$V_{\text{GS}}=10\text{ V}, I_{\text{D}}=20\text{ A}$	-	14	16	m Ω
		$V_{\text{GS}}=6\text{ V}, I_{\text{D}}=10\text{ A}$	-	18	33	
Gate resistance	R_{G}		-	1.4	-	Ω
Transconductance	g_{fs}	$ V_{\text{DS}} >2 I_{\text{D}} R_{\text{DS(on)max}}, I_{\text{D}}=20\text{ A}$	16	33	-	S

Parameter	Symbol	Conditions	Values			Unit
			min.	typ.	max.	

Dynamic characteristics

Input capacitance	C_{iss}	$V_{GS}=0\text{ V}, V_{DS}=50\text{ V}, f=1\text{ MHz}$	-	1300	1700	pF
Output capacitance	C_{oss}		-	240	320	
Reverse transfer capacitance	C_{rss}		-	11	-	
Turn-on delay time	$t_{d(on)}$	$V_{DD}=50\text{ V}, V_{GS}=10\text{ V}, I_D=10\text{ A}, R_{G,ext}=1.6\ \Omega$	-	13.0	-	ns
Rise time	t_r		-	10.0	-	
Turn-off delay time	$t_{d(off)}$		-	22.0	-	
Fall time	t_f		-	5.0	-	

Gate Charge Characteristics⁵⁾

Gate to source charge	Q_{gs}	$V_{DD}=50\text{ V}, I_D=10\text{ A}, V_{GS}=0\text{ to }10\text{ V}$	-	5.7	-	nC
Gate charge at threshold	$Q_{g(th)}$		-	3.8	-	
Gate to drain charge	Q_{gd}		-	3.4	-	
Switching charge	Q_{sw}		-	5.3	-	
Gate charge total	Q_g		-	19	25	
Gate plateau voltage	$V_{plateau}$		-	4.2	-	V
Output charge	Q_{oss}	$V_{DD}=40\text{ V}, V_{GS}=0\text{ V}$	-	25	33	nC

Reverse Diode

Diode continuous forward current	I_S	$T_C=25\text{ }^\circ\text{C}$	-	-	40	A
Diode pulse current	$I_{S,pulse}$		-	-	160	
Diode forward voltage	V_{SD}	$V_{GS}=0\text{ V}, I_F=20\text{ A}, T_j=25\text{ }^\circ\text{C}$	-	0.9	1.2	V
Reverse recovery time	t_{rr}	$V_R=50\text{ V}, I_F=10\text{ A}, di_F/dt=100\text{ A}/\mu\text{s}$	-	73	-	ns
Reverse recovery charge	Q_{rr}		-	52	-	nC

⁵⁾ See figure 16 for gate charge parameter definition

1 Power dissipation

$P_{tot}=f(T_C)$

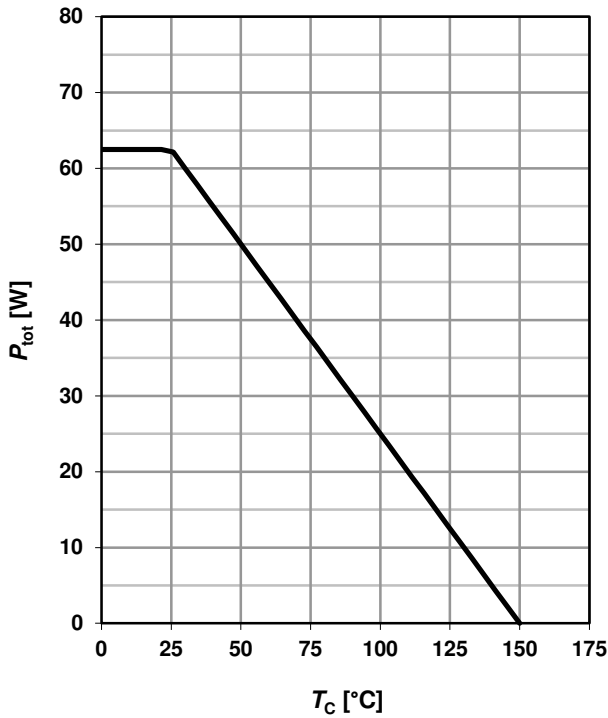

2 Drain current

$I_D=f(T_C); V_{GS} \geq 10\text{ V}$

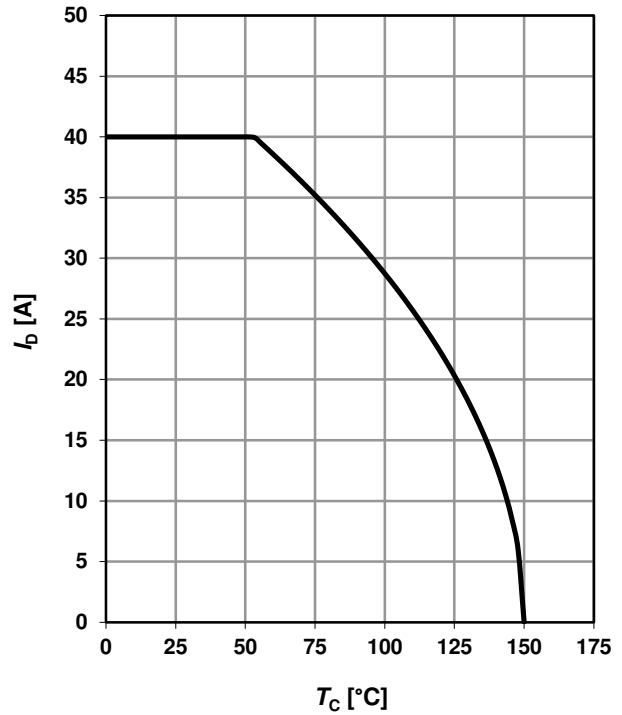

3 Safe operating area

$I_D=f(V_{DS}); T_C=25\text{ °C}; D=0$

parameter: t_p

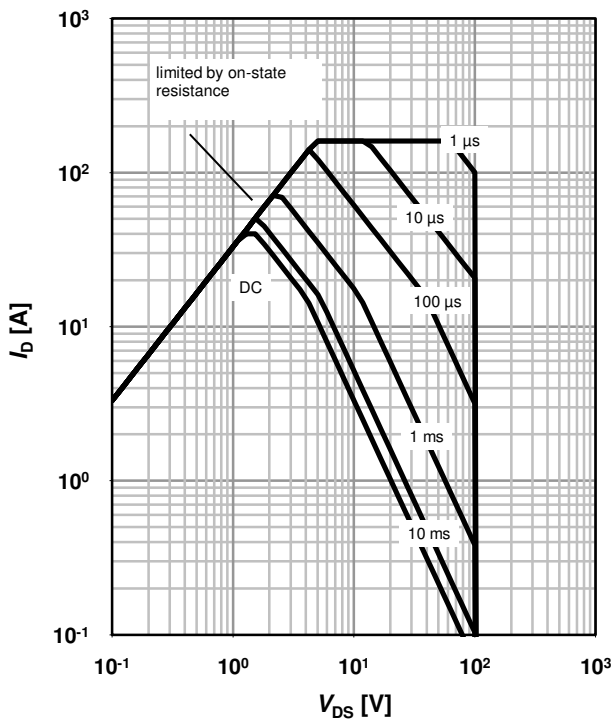

4 Max. transient thermal impedance

$Z_{thJC}=f(t_p)$

parameter: $D=t_p/T$

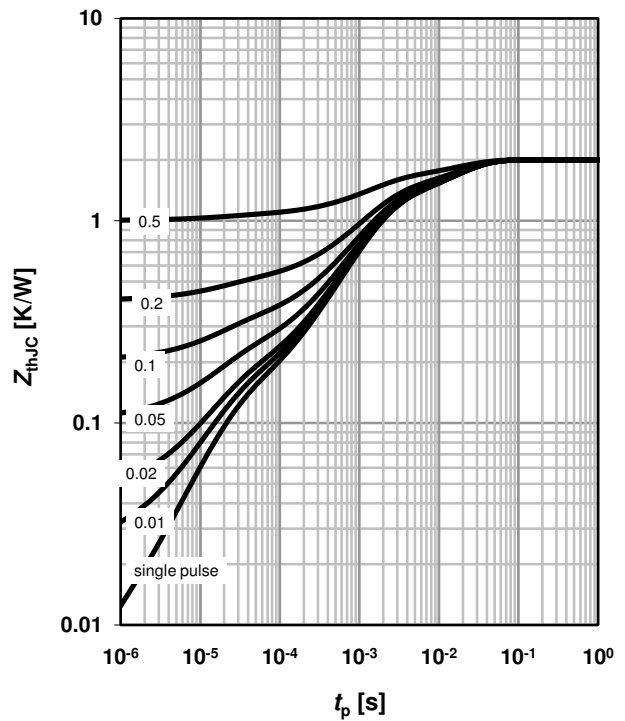

5 Typ. output characteristics

$I_D = f(V_{DS}); T_j = 25\text{ }^\circ\text{C}$

parameter: V_{GS}

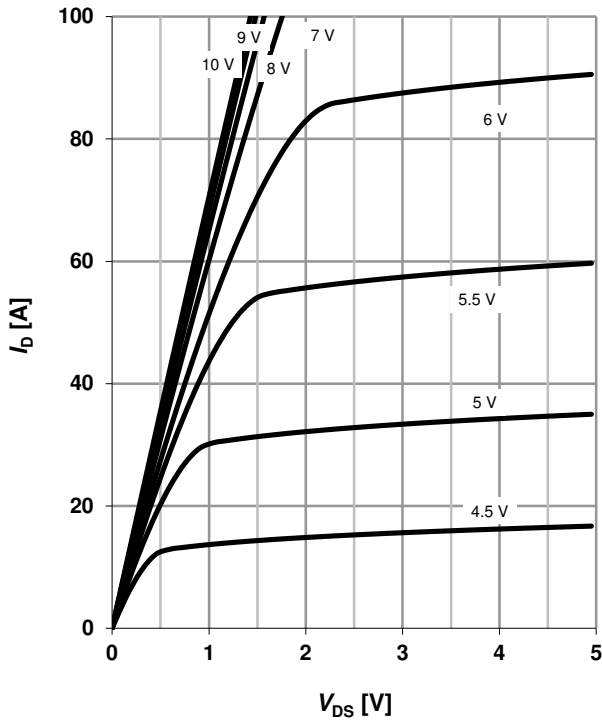

6 Typ. drain-source on resistance

$R_{DS(on)} = f(I_D); T_j = 25\text{ }^\circ\text{C}$

parameter: V_{GS}

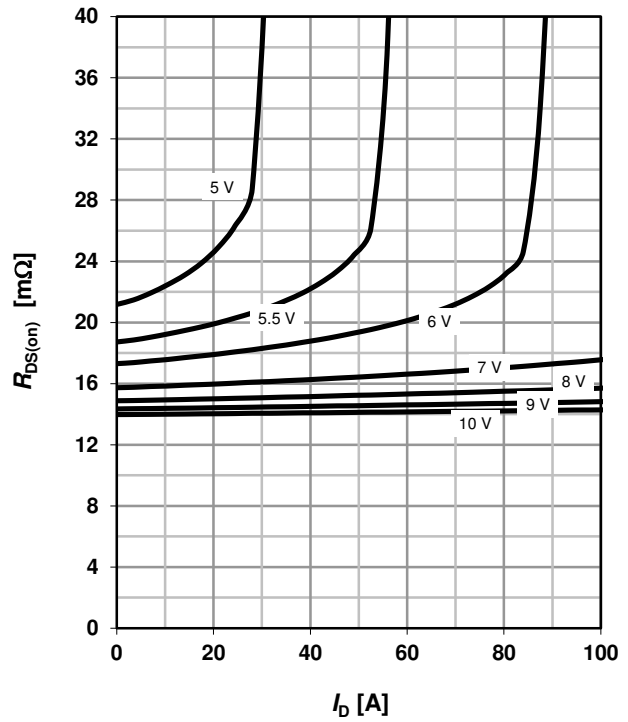

7 Typ. transfer characteristics

$I_D = f(V_{GS}); |V_{DS}| > 2|I_D|R_{DS(on)max}$

parameter: T_j

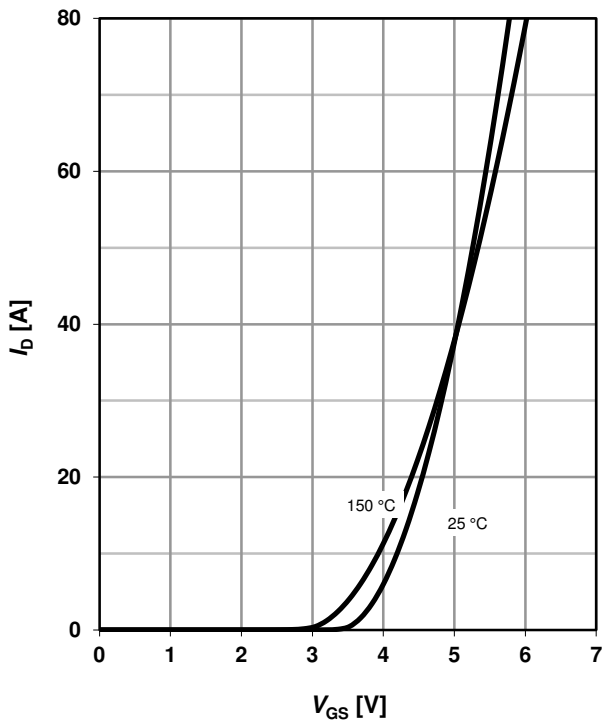

8 Typ. forward transconductance

$g_{fs} = f(I_D); T_j = 25\text{ }^\circ\text{C}$

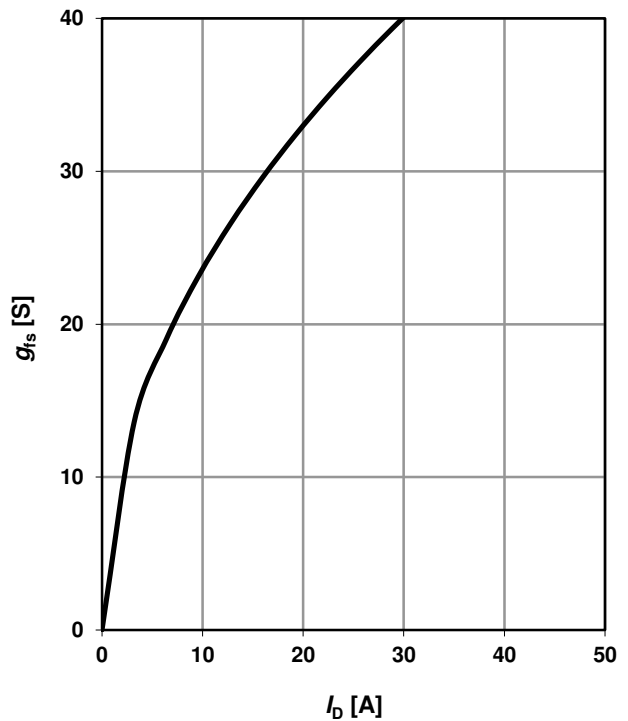

9 Drain-source on-state resistance

$R_{DS(on)}=f(T_j); I_D=20\text{ A}; V_{GS}=10\text{ V}$

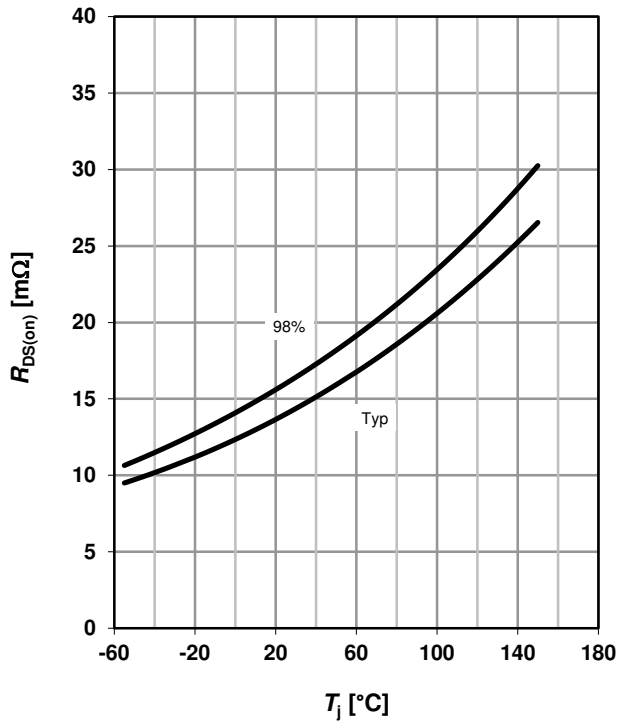

10 Typ. gate threshold voltage

$V_{GS(th)}=f(T_j); V_{GS}=V_{DS}$

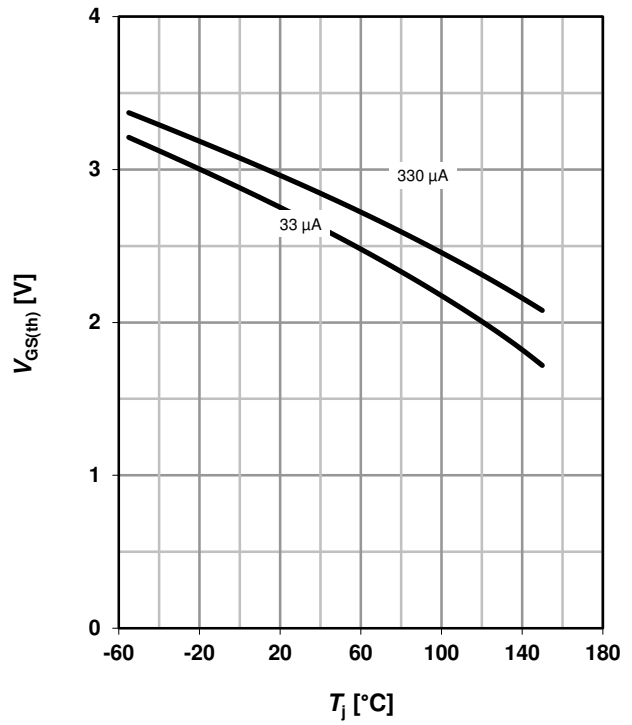

11 Typ. capacitances

$C=f(V_{DS}); V_{GS}=0\text{ V}; f=1\text{ MHz}$

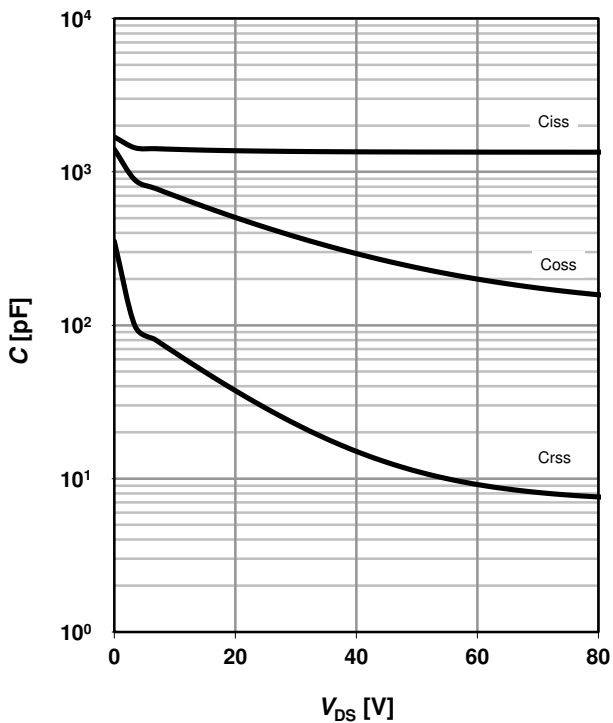

12 Forward characteristics of reverse diode

$I_F=f(V_{SD})$

parameter: T_j

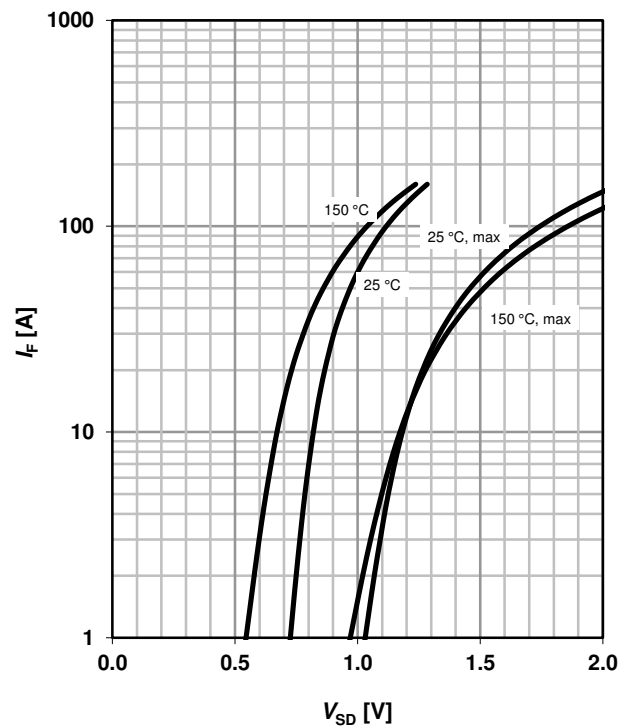

13 Avalanche characteristics

$I_{AS}=f(t_{AV}); R_{GS}=25 \Omega$

parameter: $T_{j(\text{start})}$

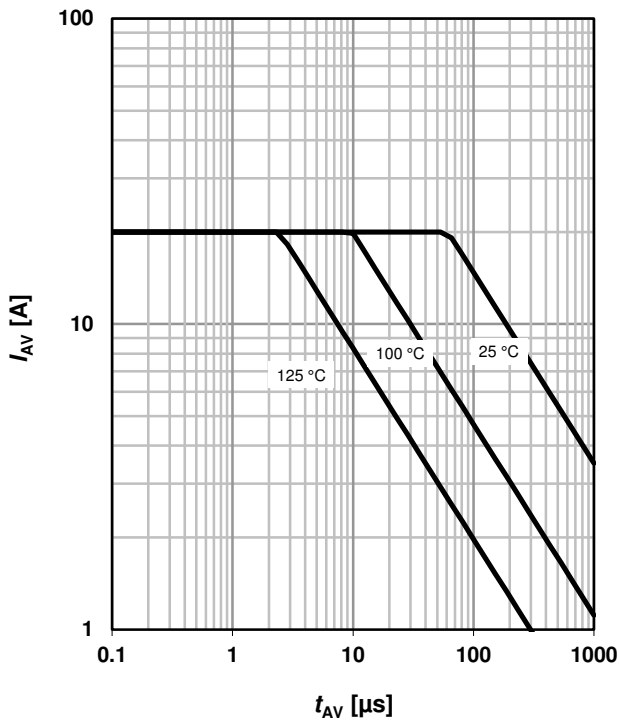

14 Typ. gate charge

$V_{GS}=f(Q_{\text{gate}}); I_D=10 \text{ A pulsed}$

parameter: V_{DD}

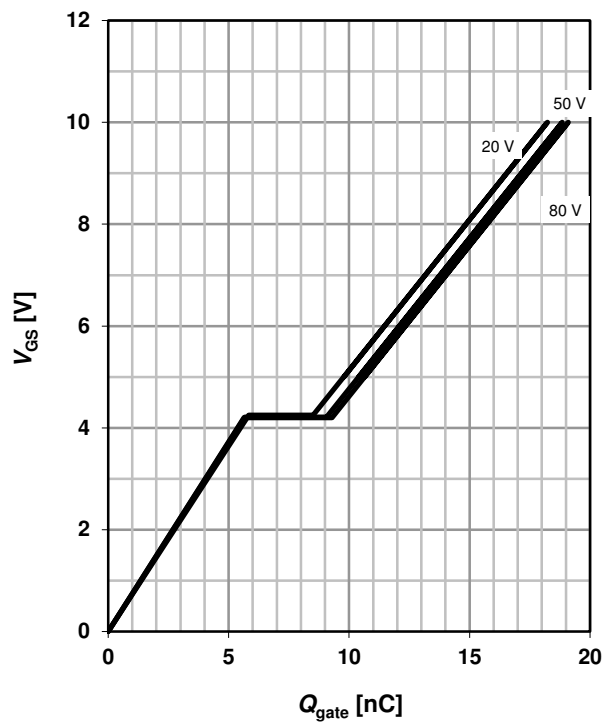

15 Drain-source breakdown voltage

$V_{BR(DSS)}=f(T_j); I_D=1 \text{ mA}$

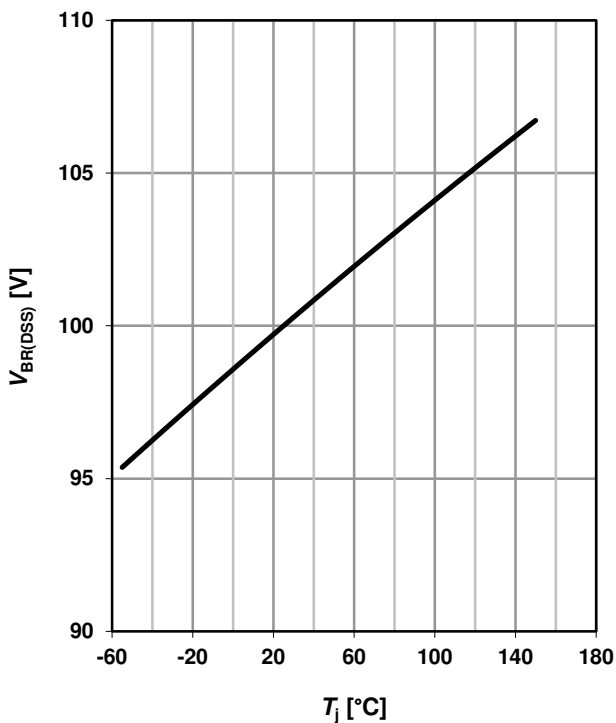

16 Gate charge waveforms

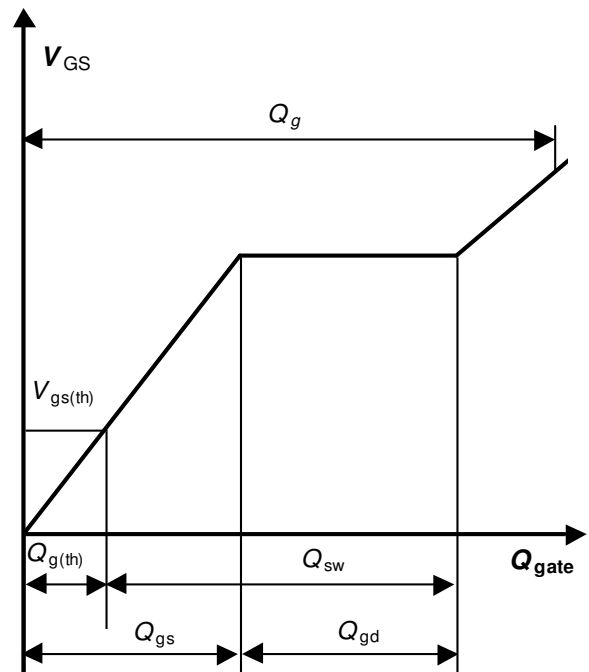

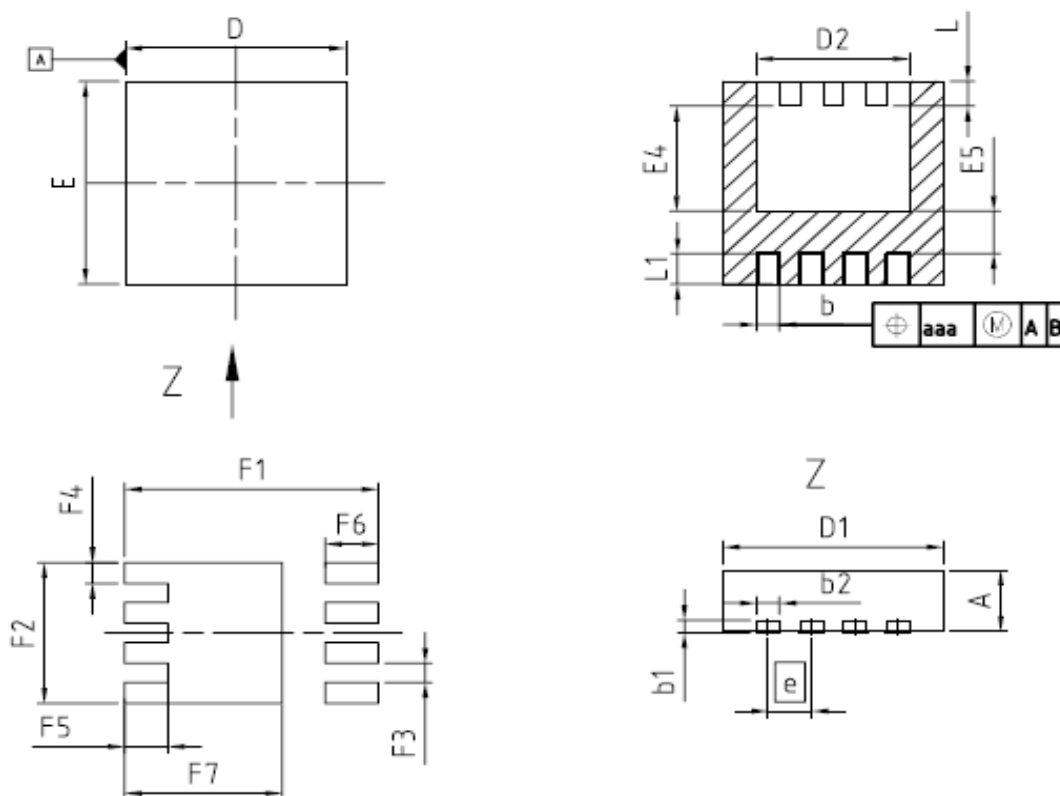
Package Outline: PG-TSDSON-8

DIM	MILLIMETERS		INCHES	
	MIN	MAX	MIN	MAX
A	0,90	1,10	0,035	0,043
b	0,24	0,44	0,009	0,017
b1	0,10	0,30	0,004	0,012
b2	0,20	0,44	0,008	0,017
D=D1	3,20	3,40	0,126	0,134
D2	2,15	2,45	0,085	0,096
E	3,20	3,40	0,126	0,134
E4	1,60	1,81	0,063	0,071
E5	0,59	0,86	0,023	0,034
e	0,65		0,026	
N	8		8	
L	0,30	0,56	0,012	0,022
L1	0,33	0,60	0,013	0,024
aaa	0,25		0,010	
F1	3,80		0,150	
F2	2,29		0,090	
F3	0,31		0,012	
F4	0,34		0,013	
F5	0,65		0,026	
F6	0,80		0,031	
F7	2,36		0,093	

DOCUMENT NO. Z8B00131645
SCALE 0 2,5 5mm
EUROPEAN PROJECTION
ISSUE DATE 17-09-2008
REVISION 02

Footprint
Dimensions in mm

Revision History

BSZ160N10NS3

Revision: 2015-10-05, Rev. 2.1

Previous Revision

Revision	Date	Subjects (major changes since last revision)
2.1	2015-10-05	Update Id condition for Vgs(th) and Tj to Ta condition for "Maximum ratings"

We Listen to Your Comments

Any information within this document that you feel is wrong, unclear or missing at all? Your feedback will help us to continuously improve the quality of this document. Please send your proposal (including a reference to this document) to:

erratum@infineon.com

Published by

Infineon Technologies AG

81726 München, Germany

© 2015 Infineon Technologies AG

All Rights Reserved.

Legal Disclaimer

The information given in this document shall in no event be regarded as a guarantee of conditions or characteristics. With respect to any examples or hints given herein, any typical values stated herein and/or any information regarding the application of the device, Infineon Technologies hereby disclaims any and all warranties and liabilities of any kind, including without limitation, warranties of non-infringement of intellectual property rights of any third party.

Information

For further information on technology, delivery terms and conditions and prices please contact your nearest Infineon Technologies Office (www.infineon.com).

Warnings

Due to technical requirements, components may contain dangerous substances. For information on the types in question, please contact the nearest Infineon Technologies Office.

The Infineon Technologies component described in this Data Sheet may be used in life-support devices or systems and/or automotive, aviation and aerospace applications or systems only with the express written approval of Infineon Technologies, if a failure of such components can reasonably be expected to cause the failure of that life-support, automotive, aviation and aerospace device or system or to affect the safety or effectiveness of that device or system. Life support devices or systems are intended to be implanted in the human body or to support and/or maintain and sustain and/or protect human life. If they fail, it is reasonable to assume that the health of the user or other persons may be endangered.

Mouser Electronics

Authorized Distributor

Click to View Pricing, Inventory, Delivery & Lifecycle Information:

[Infineon:](#)

[BSZ160N10NS3 G](#) [BSZ160N10NS3GATMA1](#)